

## AD9054A

### FEATURES

- 200 MSPS Guaranteed Conversion Rate**
- 135 MSPS Low Cost Version Available**
- 350 MHz Analog Bandwidth**
- 1 V p-p Analog Input Range**
- Internal +2.5 V Reference and T/H**
- Low Power: 500 mW**
- +5 V Single Supply Operation**
- TTL Output Interface**
- Single or Demultiplexed Output Ports**

### APPLICATIONS

- RGB Graphics Processing**
- High Resolution Video**
- Digital Data Storage Read Channels**
- Digital Communications**
- Digital Instrumentation**
- Medical Imaging**

### GENERAL DESCRIPTION

The AD9054A is an 8-bit monolithic analog-to-digital converter optimized for high speed, low power, small size and ease of use. With a 200 MSPS encode rate capability and full-power analog bandwidth of 350 MHz, the component is ideal for applications requiring the highest possible dynamic performance.

To minimize system cost and power dissipation, the AD9054A includes an internal +2.5 V reference and track-and-hold circuit. The user provides only a +5 V power supply and an encode clock. No external reference or driver components are required for many applications.

### FUNCTIONAL BLOCK DIAGRAM

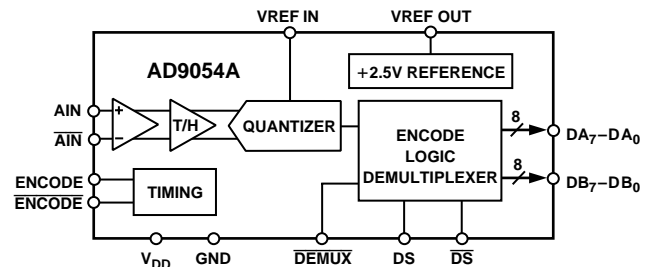

The AD9054A's encode input interfaces directly to TTL, CMOS or positive-ECL logic and will operate with single-ended or differential inputs. The user may select dual-channel or single-channel digital outputs. The dual (demultiplexed) mode interleaves ADC data through two 8-bit channels at one-half the clock rate. Operation in demultiplexed mode reduces the speed and cost of external digital interfaces while allowing the ADC to be clocked to the full 200 MSPS conversion rate. In the single-channel (nondemultiplexed) mode, all data is piped at the full clock rate to the Channel A outputs.

Fabricated with an advanced BiCMOS process, the AD9054A is provided in a space-saving 44-lead LQFP surface mount plastic package (ST-44) and specified over the full industrial (-40°C to +85°C) temperature range.

### REV. 0

Information furnished by Analog Devices is believed to be accurate and reliable. However, no responsibility is assumed by Analog Devices for its use, nor for any infringements of patents or other rights of third parties which may result from its use. No license is granted by implication or otherwise under any patent or patent rights of Analog Devices.

# AD9054A—SPECIFICATIONS

## ELECTRICAL CHARACTERISTICS ( $V_{DD} = +5\text{ V}$ , external reference, $f_s = \text{max}$ unless otherwise noted)

Parameter	Temp	Test Level	AD9054ABST-200			AD9054ABST-135			Units
			Min	Typ	Max	Min	Typ	Max	
RESOLUTION			8			8			Bits
DC ACCURACY									
Differential Nonlinearity	+25°C	I		±0.9	+1.5/-1.0		±0.9	+1.5/-1.0	LSB
	Full	VI		±1.0	+2.0/-1.0		±1.0	+2.0/-1.0	LSB
Integral Nonlinearity	+25°C	I		±0.6	±1.5		±0.6	±1.5	LSB
	Full	VI		±0.9	±2.0		±0.9	±2.0	LSB
No Missing Codes	Full	VI	Guaranteed			Guaranteed			
Gain Error <sup>1</sup>	+25°C	I		±2	±7		±2	±7	% FS
Gain Tempco <sup>1</sup>	Full	V		160			160		ppm/°C
ANALOG INPUT									
Input Voltage Range (With Respect to $\overline{\text{AIN}}$ )	Full	V		±512			±512		mV p-p
Compliance Range $\text{AIN}$ or $\overline{\text{AIN}}$	Full	V	1.8		3.2	1.8		3.2	V
Input Offset Voltage	+25°C	I		±4	±16		±4	±16	mV
	Full	VI		±8	±19		±8	±19	mV
Input Resistance	+25°C	I	36	62		36	62		kΩ
	Full	VI	23			23			kΩ
Input Capacitance	+25°C	V		4			4		pF
Input Bias Current	+25°C	I		25	50		25	50	μA
	Full	VI			75			75	μA
Analog Bandwidth, Full Power <sup>2</sup>	+25°C	V		350			350		MHz
REFERENCE OUTPUT									
Output Voltage	Full	VI	2.4	2.5	2.6	2.4	2.5	2.6	V
Temperature Coefficient	Full	V		110			110		ppm/°C
SWITCHING PERFORMANCE									
Maximum Conversion Rate ( $f_s$ )	Full	VI	200			135			MSPS
Minimum Conversion Rate ( $f_s$ )	Full	IV			25		25		MSPS
Encode Pulsewidth High ( $t_{EH}$ )	+25°C	IV	2.0		15	3.0		15	ns
Encode Pulsewidth Low ( $t_{EL}$ )	+25°C	IV	2.0		15	3.0		15	ns
Aperture Delay ( $t_A$ )	+25°C	V		0.5			0.5		ns
Aperture Uncertainty (Jitter)	+25°C	V		2.3			2.3		ps rms
Data Sync Setup Time ( $t_{SDS}$ )	+25°C	IV	0			0			ns
Data Sync Hold Time ( $t_{HDS}$ )	+25°C	IV	0.5			0.5			ns
Data Sync Pulsewidth ( $t_{PWDS}$ )	+25°C	IV	2.0			2.0			ns
Output Valid Time ( $t_V$ ) <sup>3</sup>	Full	VI	2.7	5.1		2.7	5.7		ns
Output Propagation Delay ( $t_{PD}$ ) <sup>3</sup>	Full	VI		5.9	7.9		7.5	8.5	ns
DIGITAL INPUTS									
HIGH Level Current ( $I_{IH}$ ) <sup>4</sup>	Full	VI		500	625		500	625	μA
LOW Level Current ( $I_{IL}$ ) <sup>4</sup>	Full	VI		500	625		500	625	μA
Input Capacitance	+25°C	V		3			3		pF
DIFFERENTIAL INPUTS									
Differential Signal Amplitude ( $V_{ID}$ )	Full	IV	400			400			mV
HIGH Input Voltage ( $V_{IHD}$ )	Full	IV	1.5		$V_{DD}$	1.5		$V_{DD}$	V
LOW Input Voltage ( $V_{ILD}$ )	Full	IV	0		$V_{DD} - 0.4$	0		$V_{DD} - 0.4$	V
Common-Mode Input ( $V_{ICM}$ )	Full	IV	1.5			1.5			V
DEMUX INPUT									
HIGH Input Voltage ( $V_{IH}$ )	Full	IV	2.0		$V_{DD}$	2.0		$V_{DD}$	V
LOW Input Voltage ( $V_{IL}$ )	Full	IV	0		0.8	0		0.8	V
DIGITAL OUTPUTS									
HIGH Input Voltage ( $V_{OH}$ )	Full	VI	2.4			2.4			V
LOW Input Voltage ( $V_{OL}$ )	Full	VI			0.4			0.4	V
Output Coding			Binary			Binary			

Parameter	Temp	Test Level	AD9054ABST-200			AD9054ABST-135			Units
			Min	Typ	Max	Min	Typ	Max	
<b>POWER SUPPLY</b>									
V <sub>DD</sub> Supply Current (I <sub>DD</sub> )	Full	VI		128	145		120	140	mA
Power Dissipation <sup>5,6</sup>	Full	VI		640	725		600	700	mW
Power Supply Sensitivity <sup>7</sup>	+25°C	I		0.005	0.015		0.005	0.015	V/V
<b>DYNAMIC PERFORMANCE<sup>8</sup></b>									
Transient Response	+25°C	V		1.5			1.5		ns
Overshoot Recovery Time	+25°C	V		1.5			1.5		ns
Signal-to-Noise Ratio (SNR) (Without Harmonics)									
f <sub>IN</sub> = 19.7 MHz	+25°C	IV	42	45		42	45		dB
	Full	V		45			45		dB
f <sub>IN</sub> = 49.7 MHz	+25°C	I	42	45		42	45		dB
	Full	V		45			45		dB
f <sub>IN</sub> = 70.1 MHz	+25°C	I	42	45					dB
	Full	V		45					dB
Signal-to-Noise Ratio (SINAD) (With Harmonics)									
f <sub>IN</sub> = 19.7 MHz	+25°C	IV	40	43		40	43		dB
	Full	V		43			43		dB
f <sub>IN</sub> = 49.7 MHz	+25°C	I	40	43		40	43		dB
	Full	V		43			43		dB
f <sub>IN</sub> = 70.1 MHz	+25°C	I	39	42					dB
	Full	V		42					dB
Effective Number of Bits									
f <sub>IN</sub> = 19.7 MHz	+25°C	IV	6.35	6.85		6.35	6.85		Bits
f <sub>IN</sub> = 49.7 MHz	+25°C	I	6.35	6.85		6.35	6.85		Bits
f <sub>IN</sub> = 70.1 MHz	+25°C	I	6.18	6.85					Bits
2nd Harmonic Distortion									
f <sub>IN</sub> = 19.7 MHz	+25°C	IV	58	63		58	63		dBc
f <sub>IN</sub> = 49.7 MHz	+25°C	I	54	59		54	59		dBc
f <sub>IN</sub> = 70.1 MHz	+25°C	I	49	55					dBc
3rd Harmonic Distortion									
f <sub>IN</sub> = 19.7 MHz	+25°C	IV	48	56		48	56		dBc
f <sub>IN</sub> = 49.7 MHz	+25°C	I	48	54		48	54		dBc
f <sub>IN</sub> = 70.1 MHz	+25°C	I	43	50					dBc
Two-Tone Intermod Distortion (IMD)									
f <sub>IN</sub> = 19.7 MHz	+25°C	V		60			60		dBc
f <sub>IN</sub> = 49.7 MHz	+25°C	V		55			55		dBc
f <sub>IN</sub> = 70.1 MHz	+25°C	V		50					dBc

## NOTES

<sup>1</sup>Gain error and gain temperature coefficient are based on the ADC only (with a fixed +2.5 V external reference).

<sup>2</sup>3 dB bandwidth with full-power input signal.

<sup>3</sup>t<sub>V</sub> and t<sub>PD</sub> are measured from the threshold crossing of the ENCODE input to valid TTL levels of the digital outputs. The output ac load during test is 5 pF (Refer to equivalent circuits Figures 5 and 6).

<sup>4</sup>I<sub>IH</sub> and I<sub>IL</sub> are valid for differential input voltages of less than 1.5 V. At higher differential voltages, the input current will increase to a maximum of 1.5 mA.

<sup>5</sup>Power dissipation is measured under the following conditions: analog input is -1 dBFS at 19.7 MHz.

<sup>6</sup>Typical thermal impedance for the ST-44 (LQFP) 44-lead package (in still air): θ<sub>JC</sub> = 20°C/W, θ<sub>CA</sub> = 35°C/W, θ<sub>JA</sub> = 55°C/W.

<sup>7</sup>A change in input offset voltage with respect to a change in V<sub>DD</sub>.

<sup>8</sup>SNR/harmonics based on an analog input voltage of -1.0 dBFS referenced to a 1.024 V full-scale input range.

Specifications subject to change without notice.

## EXPLANATION OF TEST LEVELS

## Test Level

I. 100% production tested.

II. 100% production tested at +25°C and sample tested at specified temperatures.

III. Sample tested only.

IV. Parameter is guaranteed by design and characterization testing.

V. Parameter is a typical value only.

VI. 100% production tested at +25°C; guaranteed by design and characterization testing for industrial temperature range.

# AD9054A

## ABSOLUTE MAXIMUM RATINGS\*

V <sub>DD</sub> .....	+6 V
Analog Inputs .....	V <sub>DD</sub> to 0.0 V
Digital Inputs .....	V <sub>DD</sub> to 0.0 V
VREF IN, VREF OUT .....	V <sub>DD</sub> to 0.0 V
Digital Output Current .....	20 mA
Operating Temperature .....	-55°C to +125°C
Storage Temperature .....	-65°C to +150°C
Maximum Junction Temperature .....	+175°C
Maximum Case Temperature .....	+150°C

\*Stresses above those listed under Absolute Maximum Ratings may cause permanent damage to the device. This is a stress rating only; functional operation of the device at these or any other conditions outside of those indicated in the operation sections of this specification is not implied. Exposure to absolute maximum ratings for extended periods may affect device reliability.

## ORDERING GUIDE

Model	Temperature Range	Package Option*
AD9054ABST-200	-40°C to +85°C	ST-44
AD9054ABST-135	-40°C to +85°C	ST-44
AD9054A/PCB	+25°C	Evaluation Board

\*ST = Plastic Thin Quad Flatpack (LQFP).

Table I. Output Coding

Step	A <sub>IN</sub> -A <sub>IN</sub>	Code	Binary
255	≥0.512 V	255	1111 1111
254	0.508 V	254	1111 1110
253	0.504 V	253	1111 1101
•	•	•	•
•	•	•	•
•	•	•	•
129	0.006 V	129	1000 0001
128	0.002 V	128	1000 0000
127	-0.002 V	127	0111 1111
126	-0.006 V	126	0111 1110
•	•	•	•
•	•	•	•
•	•	•	•
2	-0.504 V	2	0000 0010
1	-0.508 V	1	0000 0001
0	≤-0.512 V	0	0000 0000

## CAUTION

ESD (electrostatic discharge) sensitive device. Electrostatic charges as high as 4000 V readily accumulate on the human body and test equipment and can discharge without detection. Although the AD9054A features proprietary ESD protection circuitry, permanent damage may occur on devices subjected to high energy electrostatic discharges. Therefore, proper ESD precautions are recommended to avoid performance degradation or loss of functionality.



## PIN FUNCTION DESCRIPTIONS

Pin Number	Name	Function
1	ENCODE	Encode Clock for ADC (ADC Samples on Rising Edge of ENCODE).
2	$\overline{\text{ENCODE}}$	Encode Clock Complement (ADC Samples on Falling Edge of $\overline{\text{ENCODE}}$ ).
3, 5, 15, 18, 28, 30, 31, 36, 41	VDD	Power Supply (+5 V).
4, 6, 16, 17, 27, 29, 32, 35, 37, 40	GND	Ground.
14–7	DA <sub>0</sub> –DA <sub>7</sub>	Digital Outputs of ADC Channel A. DA <sub>7</sub> is the MSB, DA <sub>0</sub> the LSB.
19–26	DB <sub>0</sub> –DB <sub>7</sub>	Digital Outputs of ADC Channel B. DB <sub>7</sub> is the MSB, DB <sub>0</sub> the LSB.
33	VREF OUT	Internal Reference Output (+2.5 V typical); Bypass with 0.1 $\mu\text{F}$ to Ground.
34	VREF IN	Reference Input for ADC (+2.5 V typical, $\pm 4\%$ ).
38	$\overline{\text{AIN}}$	Analog Input—Complement. Connect to input signal midscale reference.
39	AIN	Analog Input—True.
42	$\overline{\text{DEMUX}}$	Format Select. LOW = Dual Channel Mode, HIGH = Single Channel Mode (Channel A Only).
43	$\overline{\text{DS}}$	Data Sync Complement.
44	DS	Data Sync—Aligns output channels in Dual-Channel Mode.

## PIN CONFIGURATION

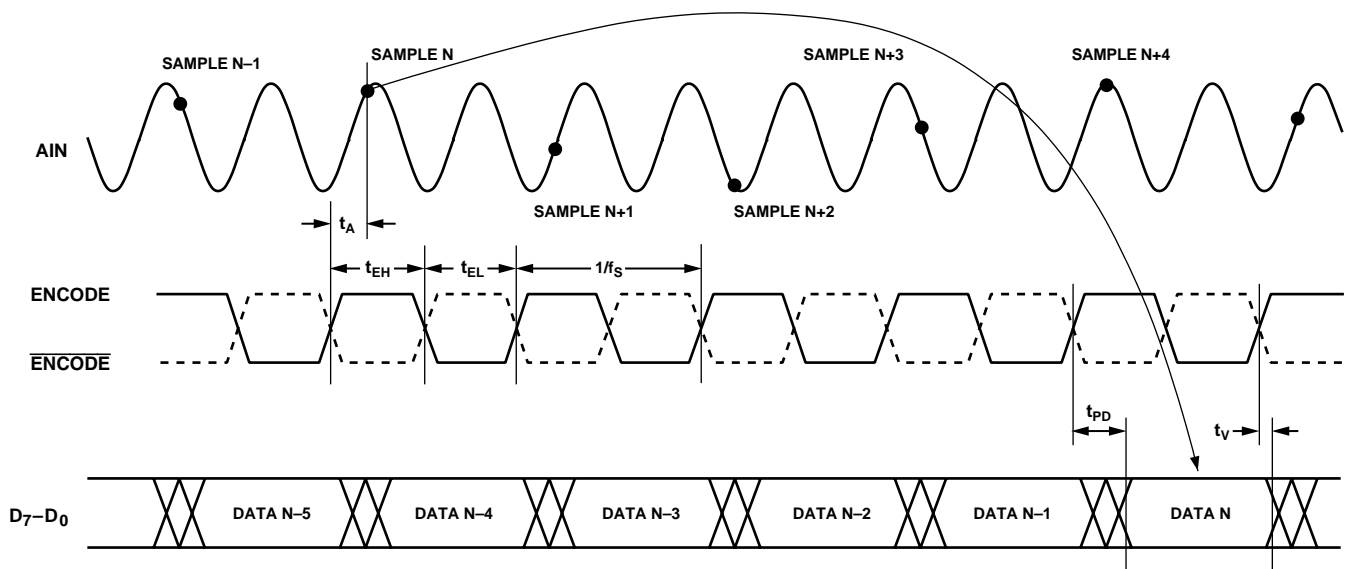
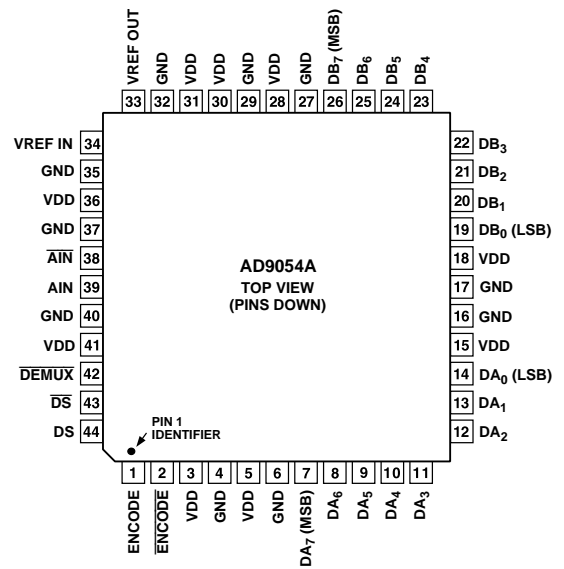

Figure 1. Timing—Single Channel Mode

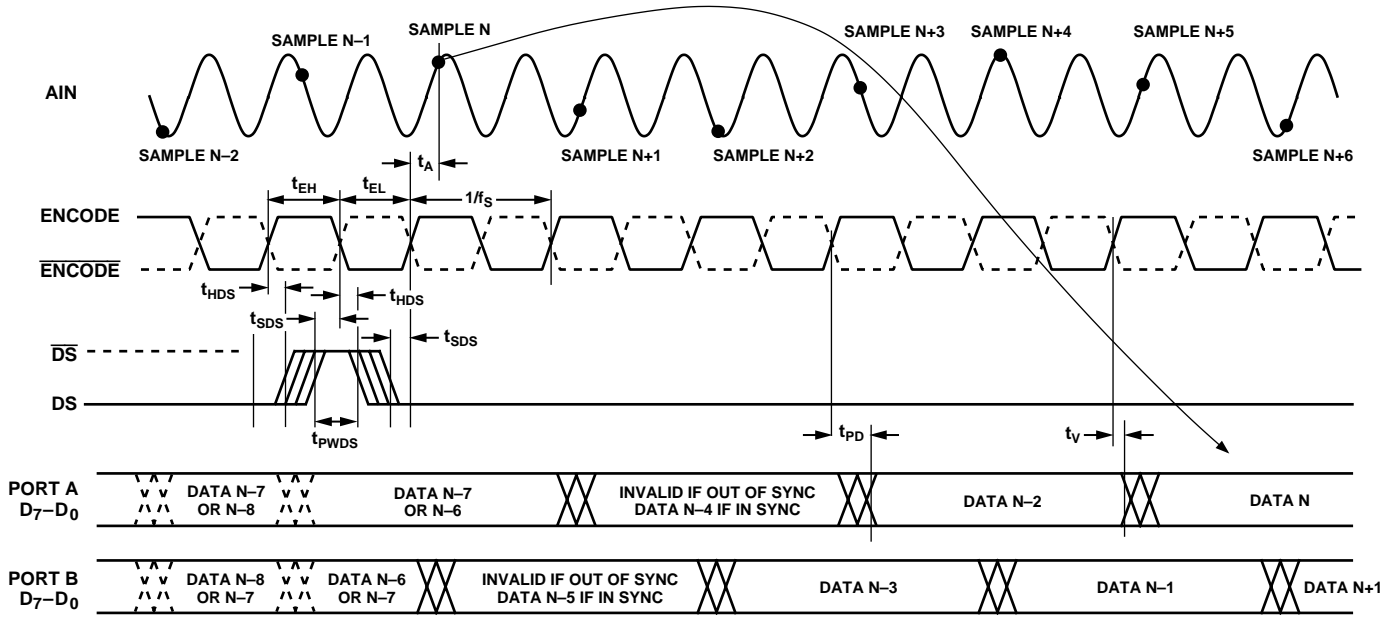

Figure 2a. Timing—Dual Channel Mode (One-Shot Data Sync)

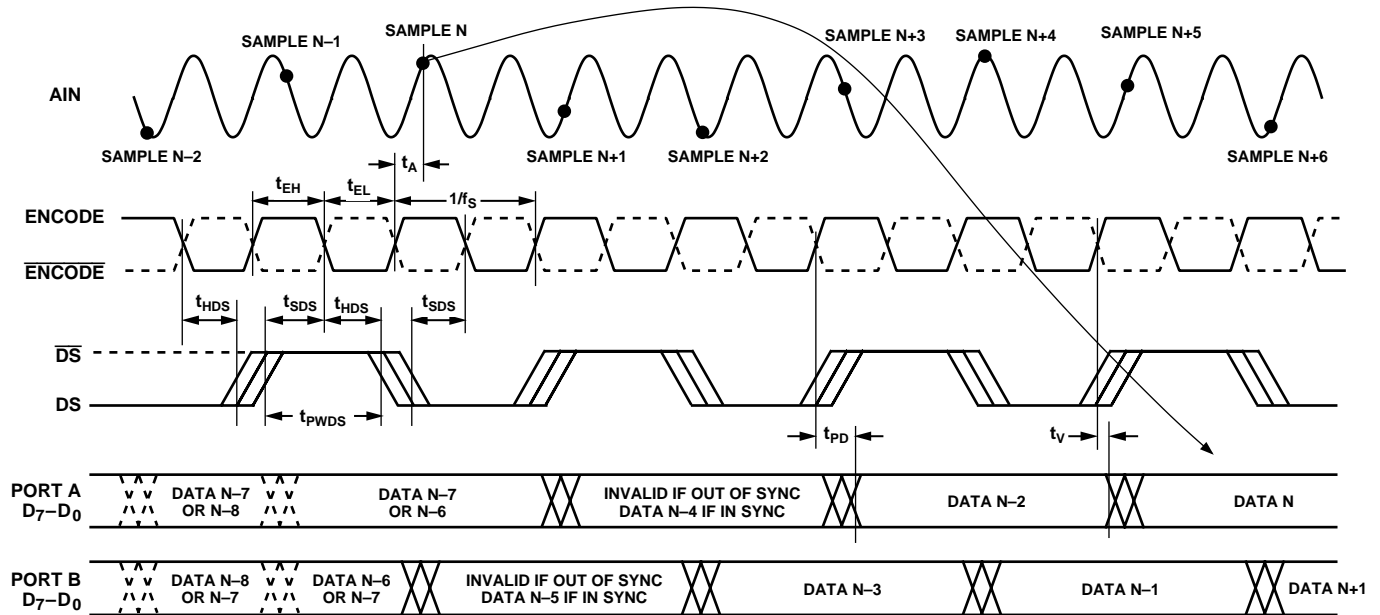

Figure 2b. Timing—Dual Channel Mode (Continuous Data Sync)

EQUIVALENT CIRCUITS

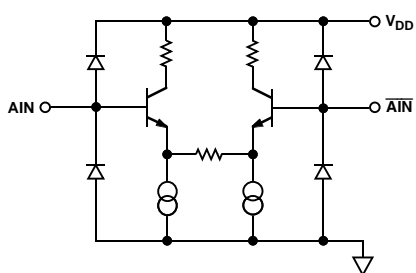

Figure 3. Equivalent Analog Input Circuit

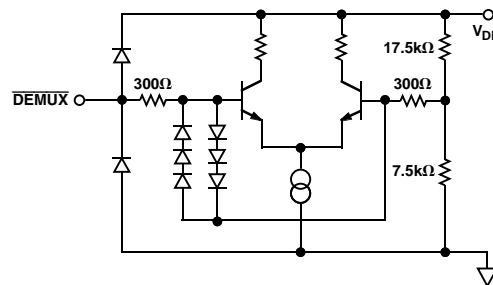

Figure 6. Equivalent  $\overline{\text{DEMUX}}$  Input Circuit

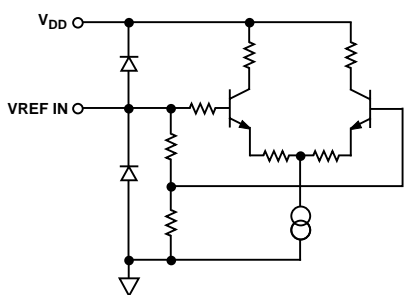

Figure 4. Equivalent Reference Input Circuit

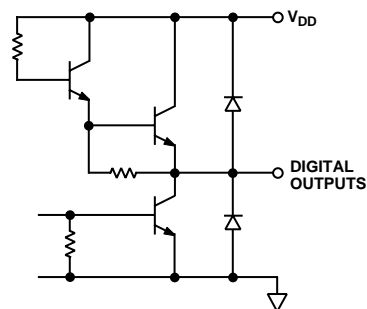

Figure 7. Equivalent Digital Output Circuit

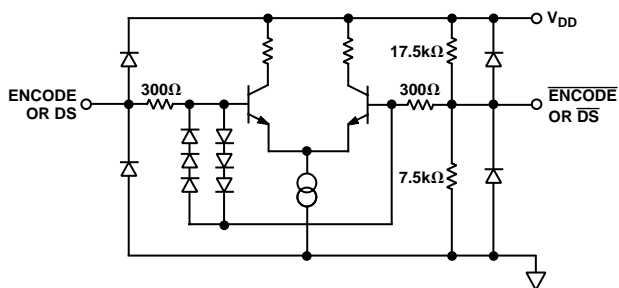

Figure 5. Equivalent ENCODE and Data Select Input Circuit

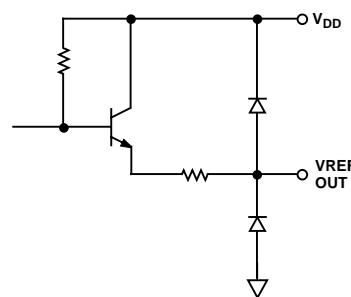

Figure 8. Equivalent Reference Output Circuit

# AD9054A

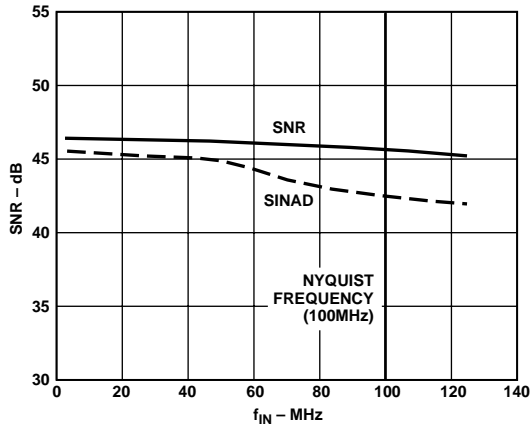

Figure 9. SNR vs.  $f_{IN}$ :  $f_S = 200$  MSPS

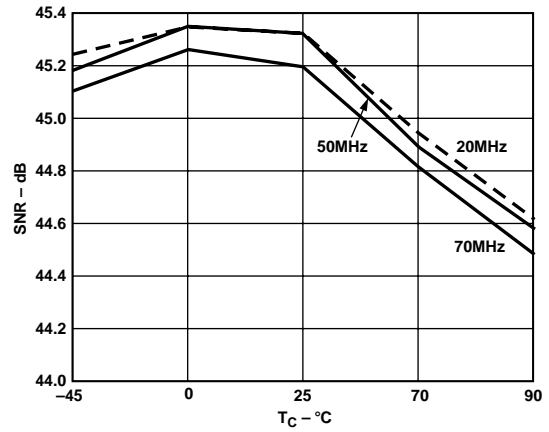

Figure 12. SNR vs. Temperature,  $f_S = 135$  MSPS

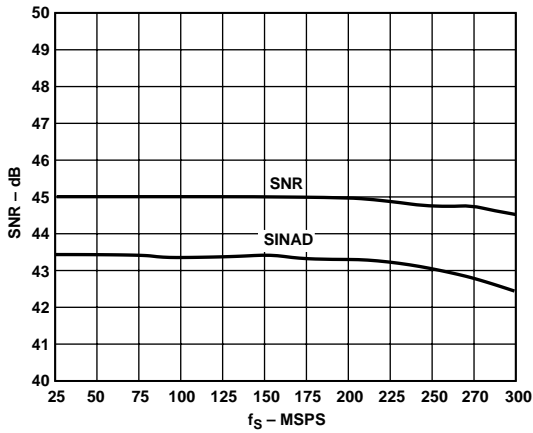

Figure 10. SNR vs.  $f_S$ :  $f_{IN} = 19.7$  MHz

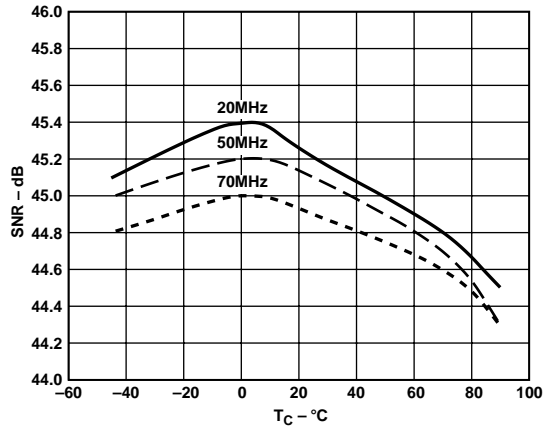

Figure 13. SNR vs. Temperature,  $f_S = 200$  MSPS

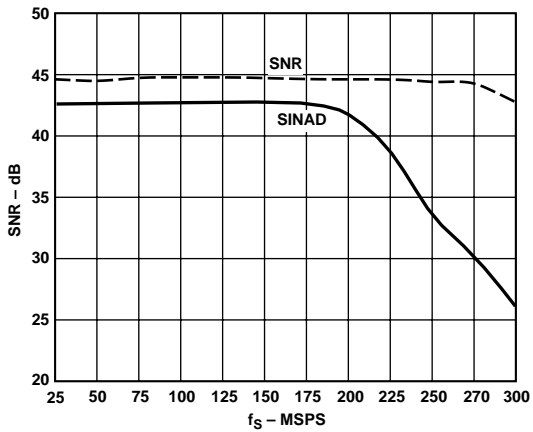

Figure 11. SNR vs.  $f_S$ :  $f_{IN} = 70.1$  MHz

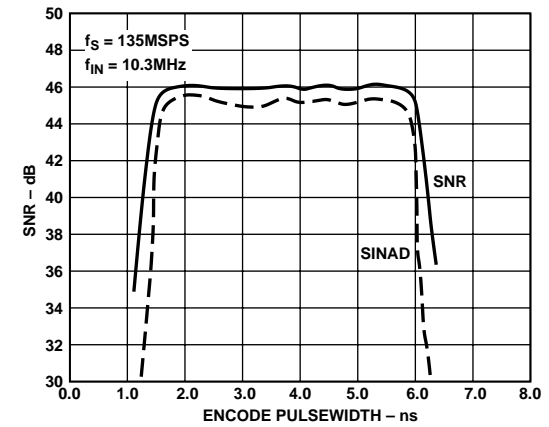

Figure 14. SNR vs. Clock Pulsewidth, ( $t_{PWH}$ ):  $f_S = 135$  MSPS



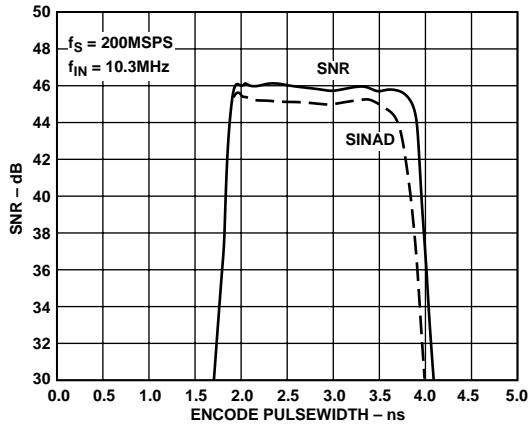

Figure 15. SNR vs. Clock Pulsewidth, ( $t_{PWH}$ ):  $f_S = 200$  MSPS

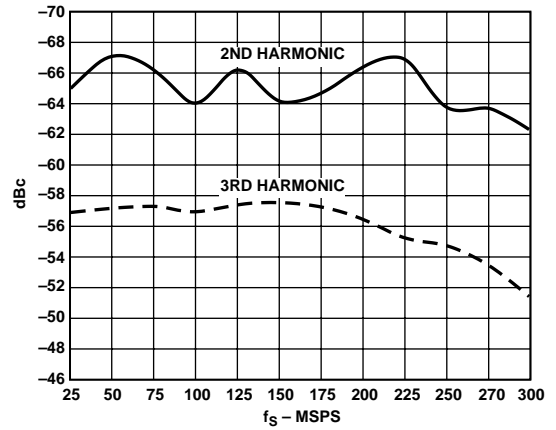

Figure 18. Harmonic Distortion vs.  $f_S$ :  $f_{IN} = 19.7$  MHz

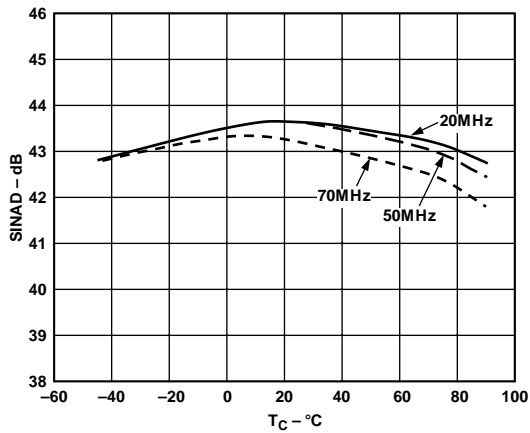

Figure 16. SINAD vs. Temperature:  $f_S = 135$  MSPS

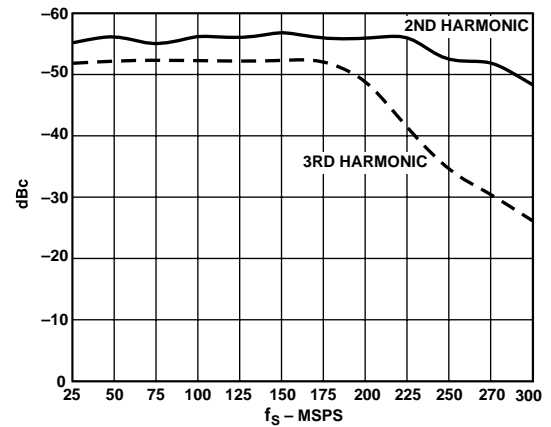

Figure 19. Harmonic Distortion vs.  $f_S$ :  $f_{IN} = 70.1$  MHz

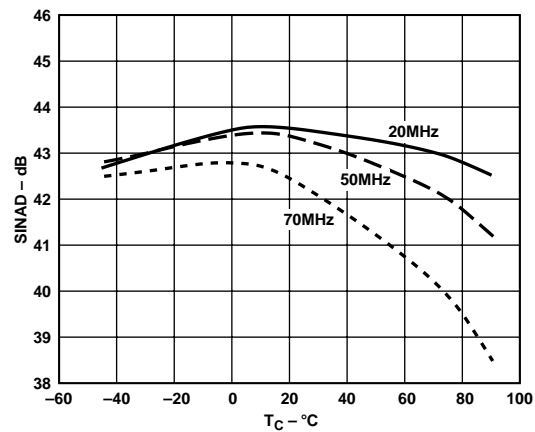

Figure 17. SINAD vs. Temperature:  $f_S = 200$  MSPS

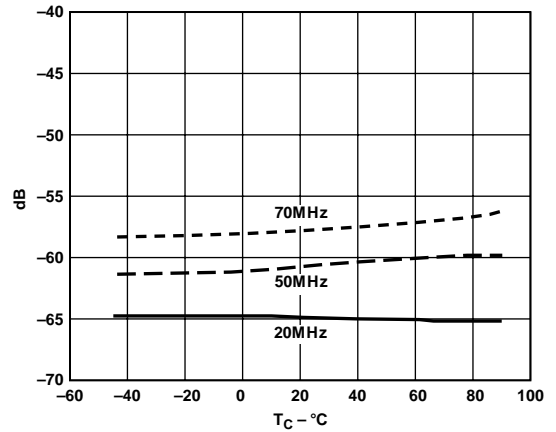

Figure 20. 2nd Harmonic vs. Temperature:  $f_S = 135$  MSPS

# AD9054A

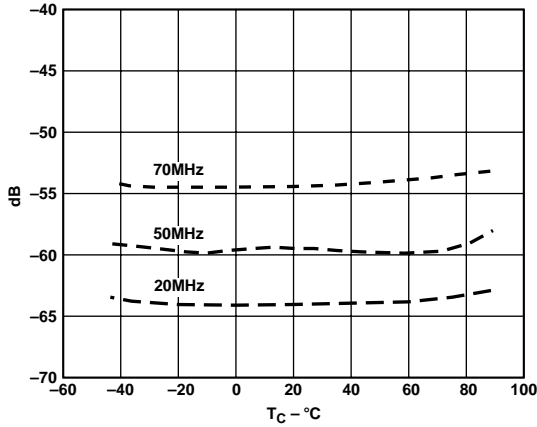

Figure 21. 2nd Harmonic vs. Temperature:  $f_S = 200$  MSPS

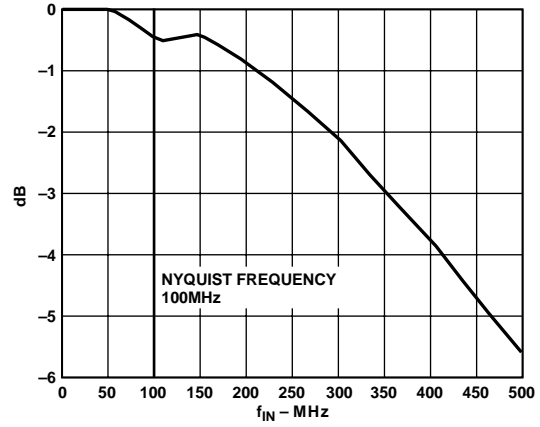

Figure 24. Frequency Response:  $f_S = 200$  MSPS

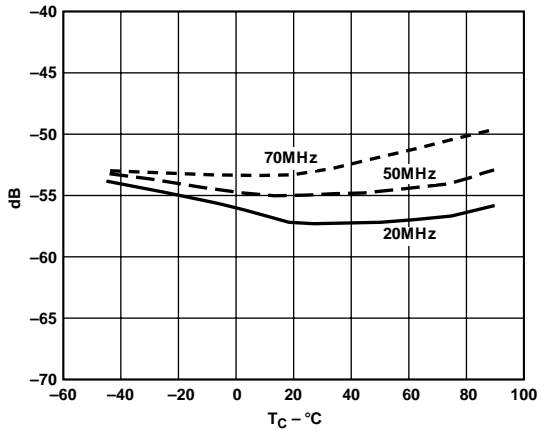

Figure 22. 3rd Harmonic vs. Temperature:  $f_S = 135$  MSPS

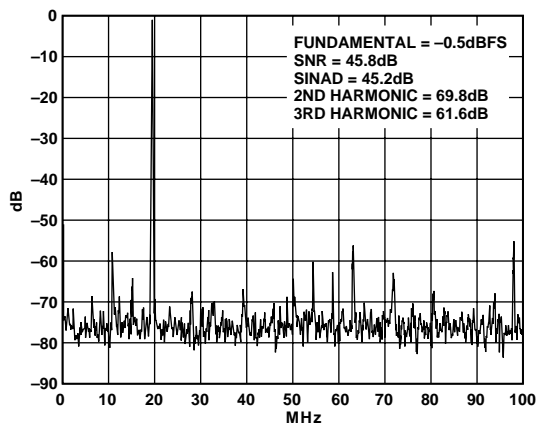

Figure 25. Spectrum:  $f_S = 200$  MSPS,  $f_{IN} = 19.7$  MHz

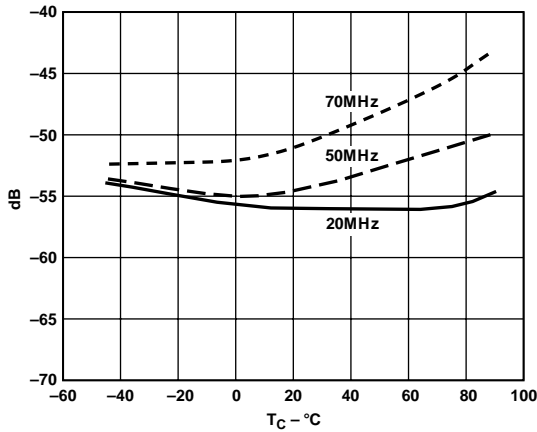

Figure 23. 3rd Harmonic vs. Temperature:  $f_S = 200$  MSPS

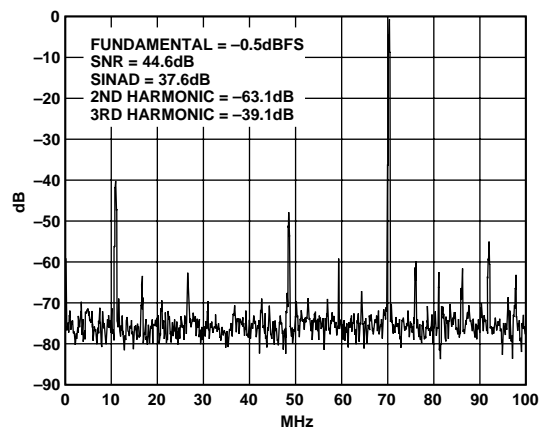

Figure 26. Spectrum:  $f_S = 200$  MSPS,  $f_{IN} = 70.1$  MHz

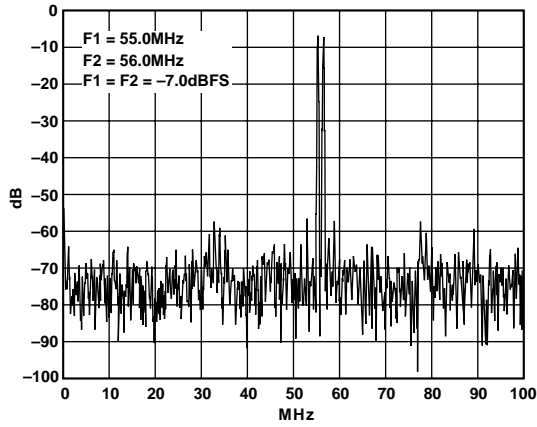

Figure 27. Two-Tone Intermodulation Distortion

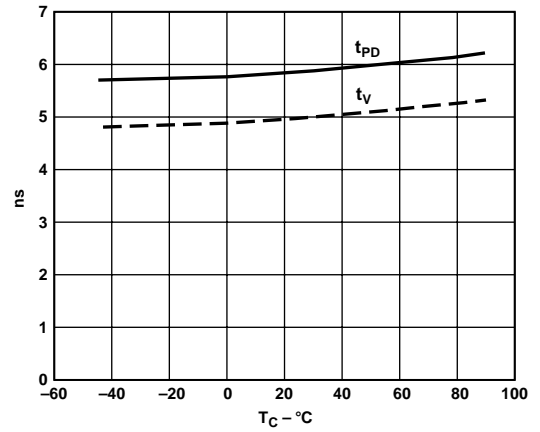

Figure 30. Output Delay vs. Temperature

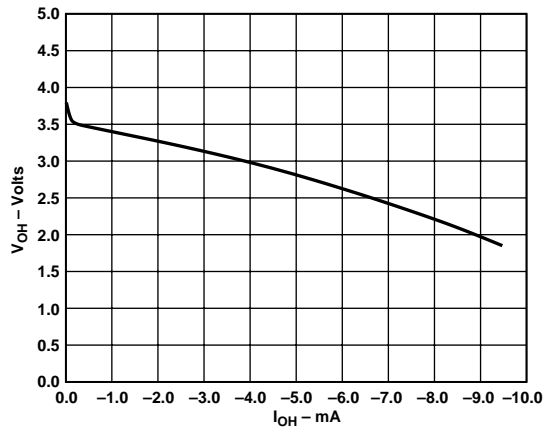

Figure 28. Output Voltage HIGH vs. Output Current

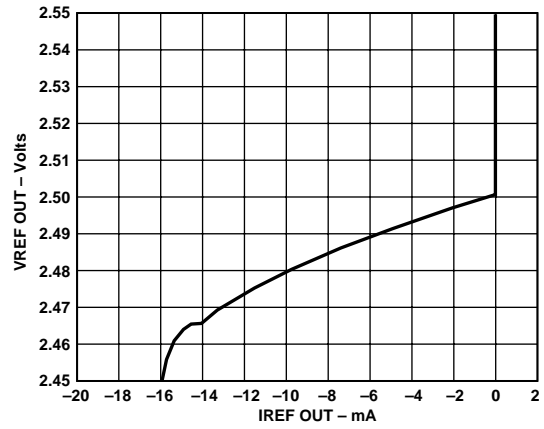

Figure 31. Reference Voltage vs. Reference Load

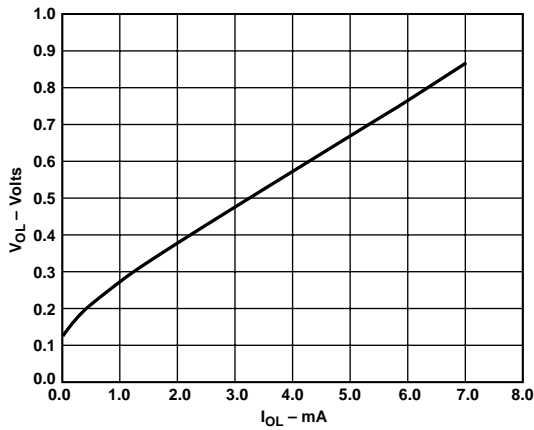

Figure 29. Output Voltage LOW vs. Output Current

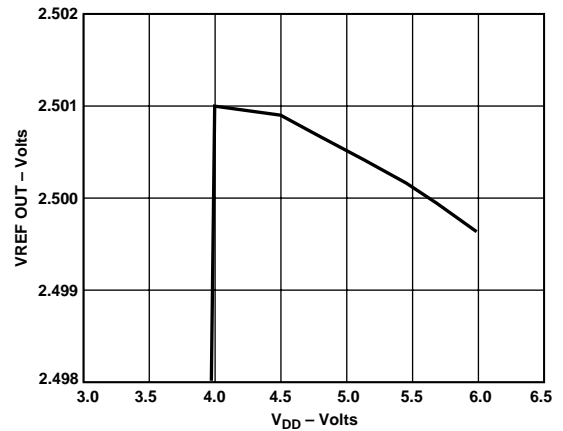

Figure 32. Reference Voltage vs. Power Supply Voltage

# AD9054A

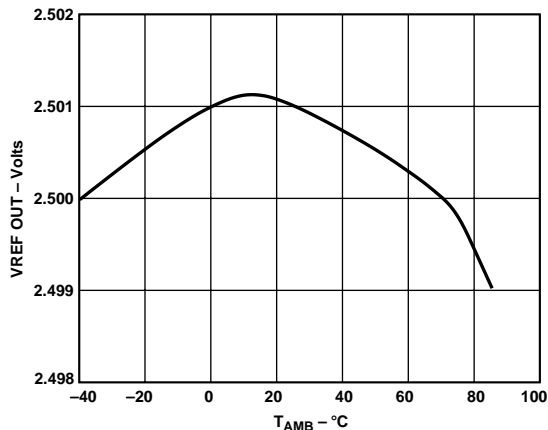

Figure 33. Reference Voltage vs. Temperature

## APPLICATION NOTES

### THEORY OF OPERATION

The AD9054A combines Analog Devices' patented MagAmp bit-per-stage architecture with flash converter technology to create a high performance, low power ADC. For ease of use the part includes an onboard reference and input logic that accepts TTL, CMOS or PECL levels.

The analog input signal is buffered by a high-speed differential amplifier and applied to a track-and-hold (T/H) circuit. This T/H captures the value of the input at the sampling instant and maintains it for the duration of the conversion. The sampling and conversion process is initiated by a rising edge on the ENCODE input. Once the signal is captured by the T/H, the four Most Significant Bits (MSBs) are sequentially encoded by the MagAmp string. The residue signal is then encoded by a flash comparator string to generate the four Least Significant Bits (LSBs). The comparator outputs are decoded and combined into the 8-bit result.

If the user has selected Single Channel Mode ( $\overline{\text{DEMUX}} = \text{HIGH}$ ), the 8-bit data word is directed to the Channel A output bank. Data are strobed to the output on the rising edge of the ENCODE input with four pipeline delays. If the user has selected Dual Channel Mode ( $\overline{\text{DEMUX}} = \text{LOW}$ ) the data are alternately directed between the A and B output banks and have five pipeline delays. At power-up, the N sample data can appear at either the A or B port. To align the data in a known state the user must strobe DATA SYNC ( $\overline{\text{DS}}$ ,  $\overline{\text{DS}}$ ) per the conditions described in the Timing section.

### Graphics Applications

The high bandwidth and low power of the AD9054A make it very attractive for applications that require the digitization of presampled waveforms, wherein the input signal rapidly slews from one level to another and is relatively stable for a period of time. Examples of these include digitizing the output of computer graphic display systems and very high speed solid state imagers.

These applications require the converter to process inputs with frequency components well in excess of the sampling rate (often with subnanosecond rise times), after which the A/D must settle and sample the input in well under one pixel time. The architecture of the AD9054A is vastly superior to older flash architectures, that not only exhibit excessive input capacitance (which is very hard to drive), but can make major errors when fed a very rapidly slewing signal. The AD9054A's extremely wide bandwidth Track/Hold circuit processes these signals without difficulty.

### Using the AD9054A

Good high speed design practices must be followed when using the AD9054A. To obtain maximum benefit, decoupling capacitors should be physically as close to the chip as possible. We recommend placing a 0.1  $\mu\text{F}$  capacitor at each power-ground pin pair (9 total) for high frequency decoupling, and including one 10  $\mu\text{F}$  capacitor for local low frequency decoupling. The VREF IN pin should also be decoupled by a 0.1  $\mu\text{F}$  capacitor.

The part should be located on a solid ground plane and output trace lengths should be short (<1 inch) to minimize transmission line effects. This avoids the need for termination resistors on the output bus and reduces the load capacitance that needs to be driven, which in turn minimizes on-chip noise due to heavy current flow in the outputs. We have obtained optimum performance on our evaluation board by tying all  $V_{\text{DD}}$  pins to a quiet analog power supply system, and tying all GND pins to a quiet analog system ground.

### Minimum Encode Rate

The minimum sampling rate for the AD9054A is 25 MHz. To achieve very high sampling rates, the track/hold circuit employs a very small hold capacitor. When operated below the minimum guaranteed sampling rate, the T/H droop becomes excessive. This is first observed as an increase in offset voltage, followed by degraded linearity at even lower frequencies.

Lower effective sampling rates may be easily supported by operating the converter in dual port output mode and using only one output channel. A majority of the power dissipated by the AD9054A is static (not related to conversion rate) so the penalty for clocking at twice the desired rate is not high.

### Reference

The AD9054A internal reference, VREF, provides a simple, cost effective reference for many applications. It exhibits reasonable accuracy and excellent stability over power supply and temperature variations. The VREF OUT pin can simply be strapped to the VREF IN pin. The internal reference can be used to drive additional loads (up to several mA), including multiple A/D converters as might be required in a triple video converter application.

When an external reference is desired for accuracy or other requirements, the AD9054A should be driven directly by the external reference source connected to pin VREF IN (VREF OUT can be left floating). The external reference can be set to  $2.5 \text{ V} \pm 0.25 \text{ V}$ . If VREF IN is raised by 10% (set to 2.75 V) the analog full-scale range will increase by 10% to  $1.024 \times 1.1 = 1.1264 \text{ V}$ . The new input range will then be  $\overline{\text{AIN}} \pm 0.5632 \text{ V}$ .

## Digital Inputs

SNR performance is directly related to the sampling clock stability in A/D converters, particularly for high input frequencies and wide bandwidths. A low jitter clock (<10 ps @ 100 MHz) is essential for optimum performance when digitizing signals that are not presampled.

ENCODE and Data Select (DS) can be driven differentially or single-ended. For single-ended operation, the complement inputs ( $\overline{\text{ENCODE}}$ ,  $\overline{\text{DS}}$ ) are internally biased to  $V_{DD}/3$  (~1.5 V) by a high impedance on-chip resistor divider (Figure 5), but they may be externally driven to establish an alternate threshold if desired. A 0.1  $\mu\text{F}$  decoupling capacitor to ground is sufficient to maintain a threshold appropriate for TTL or CMOS logic.

When driven differentially, ENCODE and DS will accommodate differential signals centered between 1.5 V and 4.5 V with a total differential swing  $\geq 800$  mV ( $V_{ID} \geq 400$  mV).

Note the 6-diode clock input protection circuitry in Figure 5. This limits the differential input voltage to  $\sim \pm 2.1$  V. When the diodes turn on, current is limited by the 300  $\Omega$  series resistor. Exceeding 2.1 V across the differential inputs will have no impact on the performance of the converter, but be aware of the clock signal distortion that may be produced by the nonlinear impedance at the converter.

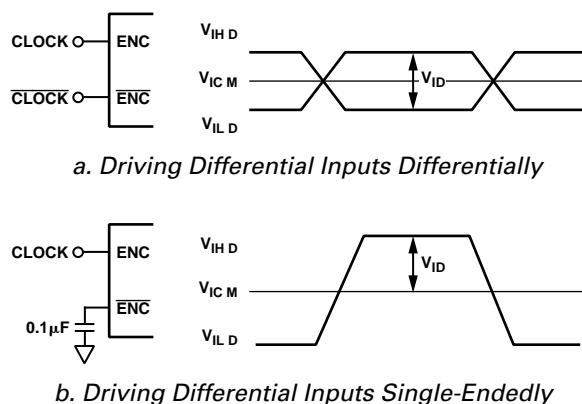

Figure 34. Input Signal Level Definitions

## Single Port Mode

When operated in a Single Port mode ( $\overline{\text{DEMUX}} = \text{HIGH}$ ), the timing of the AD9054A is similar to any high speed A/D Converter (Figure 1).

A sample is taken on every rising edge of ENCODE, and the resulting data is produced on the output pins following the FOURTH rising edge of ENCODE after the sample was taken (four pipeline delays). The output data are valid  $t_{PD}$  after the rising edge of ENCODE, and remain valid until at least  $t_V$  after the next rising edge of ENCODE.

The maximum clock rate is specified as 100 MSPS. This is recommended because the guaranteed output data valid time equals the Clock Period ( $1/f_S$ ) minus the Output Propagation Delay ( $t_{PD}$ ) plus the Output Valid Time ( $t_V$ ), which comes to 4.8 ns at 100 MHz. This is about as fast as standard logic is able to capture the data with reasonable design margins. The AD9054A will operate faster in single-channel mode if you are able to capture the data.

When operating in Single-Channel Mode, the outputs at Port B are held static in a random state.

Figure 35 shows the AD9054A used in single-channel output mode. The analog input ( $\pm 0.5$  V) is ac coupled and the ENCODE input is driven by a TTL level signal. The chip's internal reference is used.

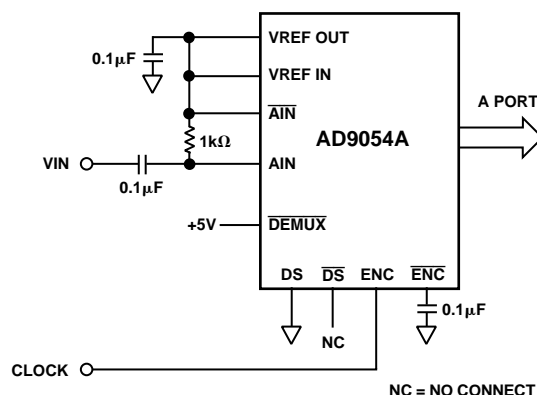

Figure 35. Single Port Mode—AC-Coupled Input—Single-Ended Encode

## Dual Port Mode

In Dual Port Mode ( $\overline{\text{DEMUX}} = \text{LOW}$ ), the conversion results are alternated between the two output ports (Figure 2). This limits the data output rate at either port to 1/2 the conversion rate (ENCODE), and supports conversion at up to 200 MSPS with TTL/CMOS compatible interfaces. Dual Channel Mode is required for guaranteed operation above 100 MSPS, but may be enabled at any specified conversion rate.

The multiplexing is controlled internally via a clock divider, which introduces a degree of ambiguity in the port assignments. Figure 2 illustrates that, prior to synchronization, either Port A or Port B may produce the even or odd samples. This is resolved by exercising the Data Sync (DS) control, a differential input (identical to the ENCODE input), which facilitates operation at high speed.

At least once after power-up, and prior to using the conversion data, the part needs to be synchronized by a falling edge (or a positive-going pulse) on DS (observing setup and hold times with respect to ENCODE). If the converter's internal timing is in conflict with the DS signal when it is exercised, then two data samples (one on each port) are corrupted as the converter is resynchronized. The converter then produces data with a known phase relationship from that point forward.

Note that if the converter is already properly synchronized, the DS pulse has no effect on the output data. This allows the converter to be continuously resynchronized by a pulse at 1/2 the ENCODE rate. This signal is often available within a system, as it represents the master clock rate for the demultiplexed output data. Of course, a single DS signal may be used to synchronize multiple A/D converters in a multichannel system.

# AD9054A

Applications that call for the AD9054A to be synchronized at power-up or only periodically during calibration/reset (i.e., valid data is not required prior to synchronization), need only be concerned with the timing of the falling edge of DS. The falling edge of DS must satisfy the setup time defined by Figure 2 and the specification table. In this case the DS hold time specification on the rising edge can be ignored.

Applications that will continuously update the synchronization command need to treat the DS signal as a pulse and satisfy timing requirements on both rising and falling edges. It is easiest to consider the DS signal in this case to be a pulse train at one half the encode rate, the positive pulse nominally bracketing the ENCODE falling edge on alternate cycles as shown in the timing diagram (Figure 2b). The falling/rising edge of DS has to satisfy a minimum setup time ( $t_{SDS}$ ) before the rising/falling edge of ENCODE; similarly, the rising/falling edge of DS has to satisfy a minimum hold time ( $t_{HDS}$ ) relative to the rising/falling edge of ENCODE. DS can fall a minimum of  $t_{HDS}$  after ENCODE falls and a maximum of  $t_{SDS}$  before the next ENCODE rises. DS can rise a minimum of  $t_{HDS}$  after ENCODE rises and a maximum of  $t_{SDS}$  before ENCODE falls. This timing requirement produces a tight timing window at higher encode rates. Synchronization by a single reset edge results in a simpler timing solution in many applications. For example, synchronization may be provided at the beginning of each graphics line or frame.

The data are presented at the output of the AD9054A in a ping-pong (alternating) fashion to optimize the performance of the converter. It may be aligned for presentation as sixteen bits in parallel by adding a register stage to the output.

In Dual Channel Mode, the converted data is produced five clock cycles after the rising edge of ENCODE on which the sample is taken (five pipeline delays).

In Figure 36, the converter is operating in Dual Port Mode, with data coming alternately out of Port A and Port B. The figure illustrates how the output data may be aligned with an output latch to produce a 16-bit output at 1/2 the conversion clock rate. The Data Sync input must be properly exercised to time the A Port with the synchronizing latch.

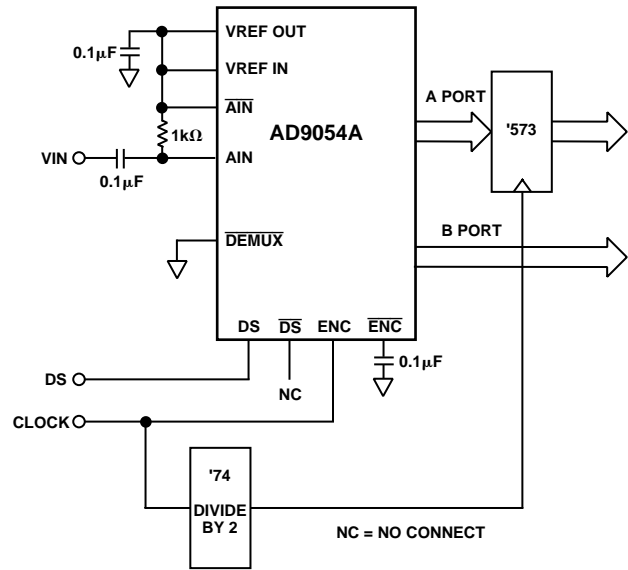

Figure 36. Dual Port Mode—Aligned Output Data

## EVALUATION BOARD

The AD9054A evaluation board offers an easy way to test the AD9054A. It provides dc biasing for the analog input, generates the latch clocks for both full speed and demuxed modes, and includes a reconstruction DAC. The board has several different modes of operation, and is shipped in the following configuration:

- DC-Coupled Analog Input
- Demuxed Outputs
- Differential Clocks
- Internal Voltage Reference.

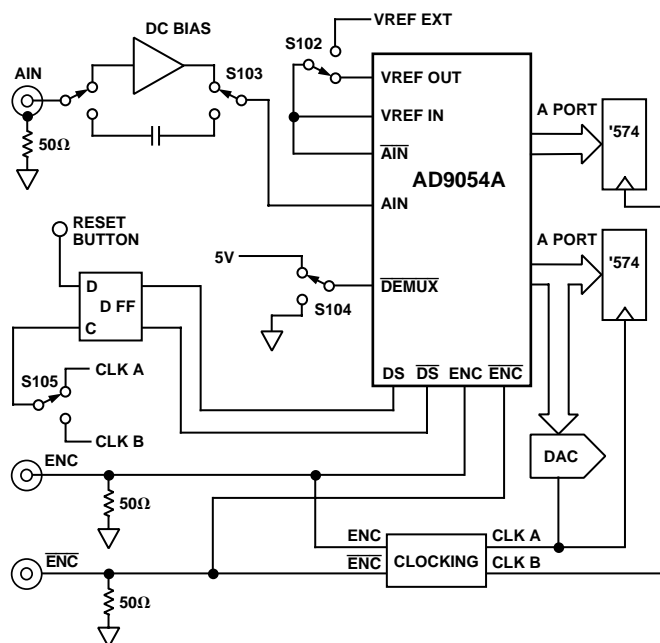

Figure 37. PCB Block Diagram

### Analog Input

The evaluation board accepts a 1 V input signal centered at ground. The board's input circuitry then biases this signal to +2.5 V in one of two ways:

1. DC-coupled through an AD9631 op amp; this is the mode in which it is shipped. Potentiometer R7 provides adjustment of the bias voltage.
2. AC-coupled through C1.

These two modes are selected by jumpers S101 and S103. For dc coupling, the S101 jumper is connected between the two left pins and the S103 jumper is connected between the two lower pins. For ac coupling, the S101 jumper is connected between the two right pins and the S103 jumper is connected between the two upper pins.

### ENCODE

The AD9054A ENCODE input can be driven two ways:

1. Differential TTL, CMOS, or PECL; it is shipped in this mode.
2. Single-ended TTL or CMOS. To use in this mode, remove R11, the 50 Ω chip resistor located next to the ENCODE input, and insert a 0.1 μF ceramic capacitor into the C5 slot. C5 is located between the ENC connector and the ENCODE input to the DUT and is marked on the back side of the board. In this mode, ENCODE is biased with internal resistors to 1.5 V, but it can be externally driven to any dc voltage.

### Voltage Reference

The AD9054A has an internal 2.5 V voltage reference. An external reference may be employed instead. The evaluation board is configured for the internal reference. To use an external reference, connect it to the (VREF) pin on the power connector and move jumper S102.

### Single Port Mode

Single Port Mode sets the AD9054A to produce data on every clock cycle on output port A only. To test in this mode, jumper S104 should be set to single channel and S106 and S107 must be set to F (for Full). The maximum speed in single port mode is 100 MSPS.

### Dual Port Mode

Dual Port or half speed output mode sets the ADC to produce data alternately on Port A and Port B. In this mode, the reset function should be implemented. To test in this mode, set jumper S104 to Dual Channel, and set S106 and S107 to D (for Dual Port). The maximum speed in this mode is 200 MSPS.

### RESET

RESET drives the AD9054A's Data Sync (DS) pins. When operating in Single Port Mode, RESET is not used. In Dual-Channel Mode it is needed for two reasons: to synchronize the timing of Port A data and Port B data with a known clock edge, as described in the data sheet, and to synchronize the evaluation board's latch clocks with the data coming out of the AD9054A. Reset can be driven in two ways: by pushing the reset button on the board, or externally, with a TTL pulse through connector J5 or J6.

### DAC Out

The DAC output is a representation of the data on output Port A only. Output Port B is not reconstructed.

### Troubleshooting

If the board does not seem to be working correctly, try the following:

- Check that all jumpers are in the correct position for the desired mode of operation.
- Push the reset button. This will align the AD9054A's data output with the half speed latch clocks.
- Switch the jumper S105 from A-R to R-B or vice-versa, then push the reset button. In demuxed mode, this will have the effect of inverting the half speed latch clocks.
- At high encode rates, the evaluation board's clock generation circuitry is sensitive to the +5 V digital power supply. At high encode rates, the +5 V digital power should be kept below +5.2 V. This is an evaluation board sensitivity and not an AD9054A sensitivity.

The AD9054A Evaluation Board is provided as a design example for customers of Analog Devices, Inc. ADI makes no warranties, express, statutory, or implied, regarding merchantability or fitness for a particular purpose.

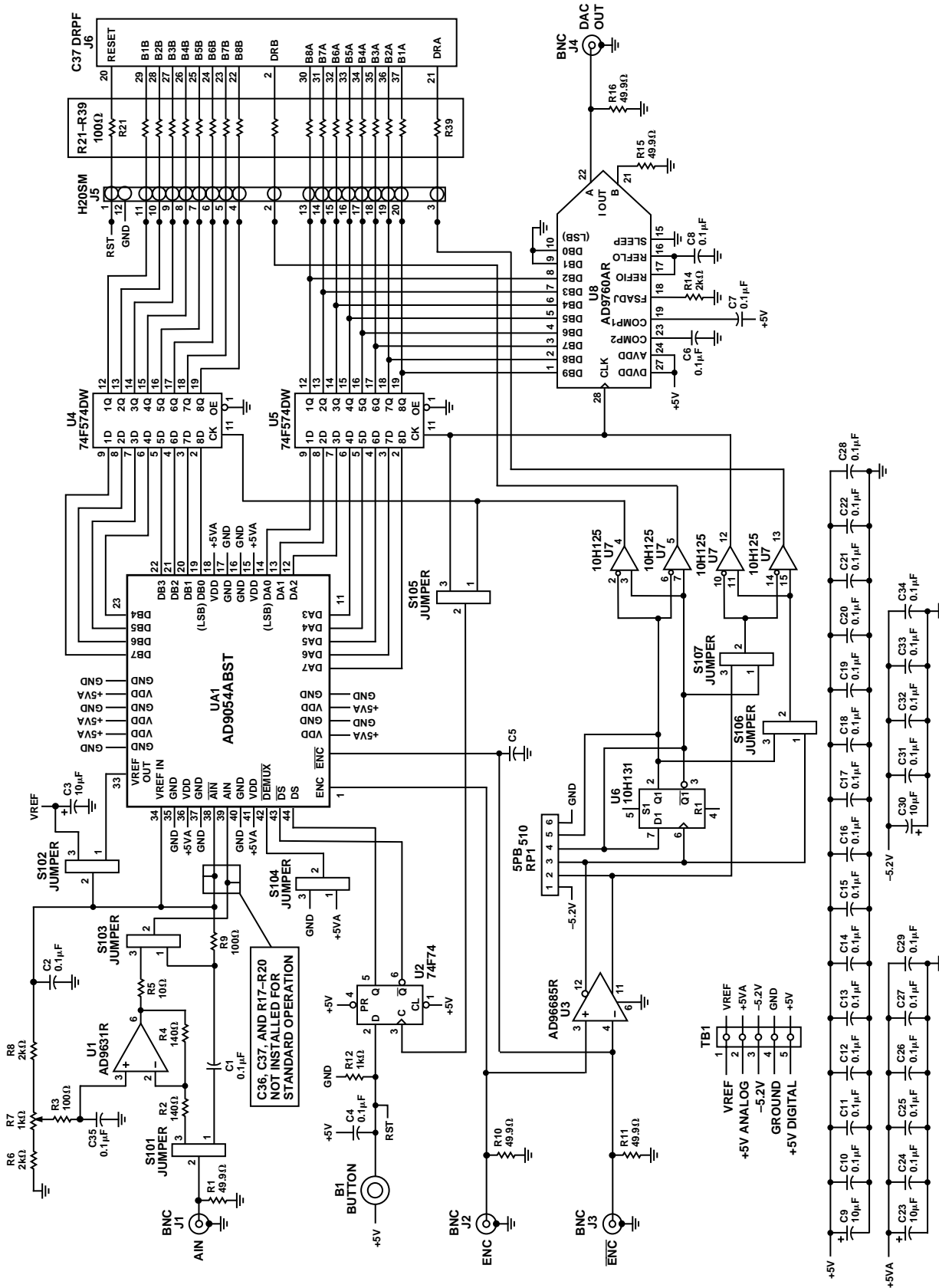

Figure 38. Evaluation Board Schematic





# AD9054A

## BILL OF MATERIALS

GS00104 REV. B

ITEM	QTY	PART NUMBER	REFERENCE	DESCRIPTION	MFG/DISTRIBUTOR
1	30	GRM40Z5U104M050BL	C1, C2, C4, C6-8, C10-C22, C24-C29, C31-C35	0.1 $\mu$ F CER CHIP CAP 0805	TTI
2	1	P10FBK-ND	R5	10 $\Omega$ SURFACE MT RES 1206	DIGI-KEY
3	21	P100FBK-ND	R3, R9, R21-R39	100 $\Omega$ SURFACE MT RES 1206	DIGI-KEY
4	4	T491C106M016AS	C3, C9, C23, C30	10 $\mu$ F TANTALUM CHIP CAP	TTI
5	2	P140FBK-ND	R2, R4	140 $\Omega$ SURFACE MT RES 1206	DIGI-KEY
6	1	P1KFBK-ND	R12	1 k $\Omega$ SURFACE MT RES 1206	DIGI-KEY
7	3	P2KFBK-ND	R6, R8, R14	2 k $\Omega$ SURFACE MT RES 1206	DIGI-KEY
8	1	3296W-102-ND	R7	1k TRIM POT TOP ADJ, 25 TURN	DIGI-KEY
9	1	K44-C37S-QJ	J6	37P D CONN RT ANG PCMT FEM	CENTURY ELEC
10	5	P49.9FBK-ND	R1, R10, R11, R15, R16	49.9 $\Omega$ SURFACE MT RES 1206	DIGI-KEY
11	1	CSC06A-01-511G	RP1	510 $\Omega$ 6P BUSED RES NETWORK	TTI
12	1	51F54113	TB1	8291Z 3-PIN TERMINAL BLOCK	NEWARK
13	1	51F54112	TB1	8291Z 2-PIN TERMINAL BLOCK	NEWARK
14	4	AMP-227699-2	J1-J4	BNC COAX CONN PCMT 5 LEAD	TIME ELEC
15	1	MC10H131P	U6	DIP-16 DUAL D FLIP-FLOP	HAMILTON/HALLMARK
16	1	MC10H125P	U7	DIP-16 QUAD ECL TO TTL TRANS	HAMILTON/HALLMARK
17	1	74F74SC-ND	U2	SO-14 FAST TTL DUAL D FLIP-FLOP	DIGI-KEY
18	1	TSW-120-08-G-S	J5	HEADER STRIP 20P GOLD MALE	SAMTEC
ALT:	1/2	90F3987	J5	40P HEADER	NEWARK
19	1	AD96685BR	U3	HIGH SPEED COMP SOIC-16	ANALOG DEVICES, INC.
20	7	S90F9280	S101-S107	SHORTING JUMPER	NEWARK
21	8	89F4700	S101-S107, GND	3-PIN HEADER (DIVIDE 1 OF THE 8 FOR 3 GND HOLES)	NEWARK
22	2	MC74F574DW	U4, U5	SO-20 OCTAL D TYPE FLIP-FLOP	HAMILTON/HALLMARK
23	1	AD9631AR	U1	SOIC-8 OP AMP	ANALOG DEVICES, INC.
24	1	AD9760AR	U8	10-BIT CMOS DAC SOIC-28	ANALOG DEVICES, INC.
25	1	AD9054ABST	UA1	8-BIT ADC IN 44-LEAD LQFP	ANALOG DEVICES, INC.
26	1	P8002SCT-ND	B1	SURFACE MOUNT MOMENTARY PUSHBUTTON	DIGI-KEY
27	4	90F1533	-	BUMPON PROTECTIVE BUMPER	NEWARK

PARTS NOT ON BILL OF MATERIALS, AND NOT TO BE INSTALLED: C5, C36, C37, R17-R20.

**OUTLINE DIMENSIONS**

Dimensions shown in inches and (mm).

**44-Lead Plastic Thin Quad Flatpack (LQFP)  
(ST-44)**

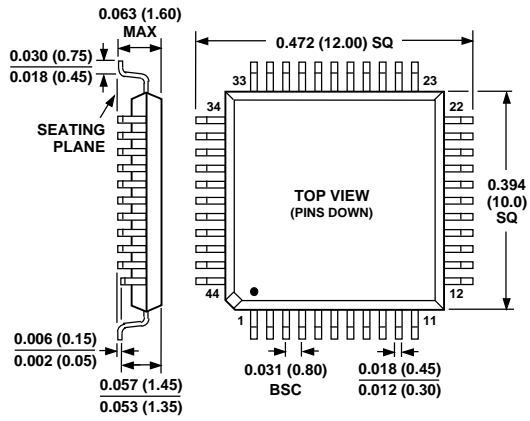

C3478-8-2/99

PRINTED IN U.S.A.