

BUH100

Designer's™ Data Sheet
SWITCHMODE NPN Silicon
Planar Power Transistor

The BUH100 has an application specific state-of-art die designed for use in 100 Watts Halogen electronic transformers.

This power transistor is specifically designed to sustain the large inrush current during either the start-up conditions or under a short circuit across the load.

This High voltage/High speed product exhibits the following main features:

- Improved Efficiency Due to the Low Base Drive Requirements:
 - High and Flat DC Current Gain h_{FE}
 - Fast Switching
- Robustness Thanks to the Technology Developed to Manufacture this Device
- Motorola "6 SIGMA" Philosophy Provides Tight and Reproducible Parametric Distributions

POWER TRANSISTOR
10 AMPERES
700 VOLTS
100 WATTS

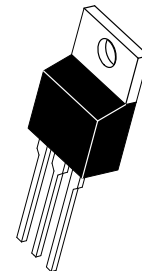
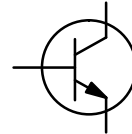

CASE 221A-06
TO-220AB

MAXIMUM RATINGS

Rating	Symbol	Value	Unit
Collector-Emitter Sustaining Voltage	V_{CEO}	400	Vdc
Collector-Base Breakdown Voltage	V_{CBO}	700	Vdc
Collector-Emitter Breakdown Voltage	V_{CES}	700	Vdc
Emitter-Base Voltage	V_{EBO}	10	Vdc
Collector Current — Continuous — Peak (1)	I_C I_{CM}	10 20	Adc
Base Current — Continuous — Peak (1)	I_B I_{BM}	4 10	Adc
*Total Device Dissipation @ $T_C = 25^\circ\text{C}$ *Derate above 25°C	P_D	100 0.8	Watt W/ $^\circ\text{C}$
Operating and Storage Temperature	T_J, T_{stg}	-65 to 150	$^\circ\text{C}$

THERMAL CHARACTERISTICS

Thermal Resistance — Junction to Case — Junction to Ambient	$R_{\theta JC}$ $R_{\theta JA}$	1.25 62.5	$^\circ\text{C/W}$
Maximum Lead Temperature for Soldering Purposes: 1/8" from case for 5 seconds	T_L	260	$^\circ\text{C}$

(1) Pulse Test: Pulse Width = 5 ms, Duty Cycle $\leq 10\%$.

Designer's and SWITCHMODE are trademarks of Motorola, Inc.

Designer's Data for "Worst Case" Conditions — The Designer's Data Sheet permits the design of most circuits entirely from the information presented. SOA Limit curves — representing boundaries on device characteristics — are given to facilitate "worst case" design.

BUH100

ELECTRICAL CHARACTERISTICS (T_C = 25°C unless otherwise noted)

Characteristic	Symbol	Min	Typ	Max	Unit
OFF CHARACTERISTICS					
Collector–Emitter Sustaining Voltage (I _C = 100 mA, L = 25 mH)	V _{CEO(sus)}	400	460		Vdc
Collector–Base Breakdown Voltage (I _{CBO} = 1 mA)	V _{CBO}	700	860		Vdc
Emitter–Base Breakdown Voltage (I _{EBO} = 1 mA)	V _{EBO}	10	12.5		Vdc
Collector Cutoff Current (V _{CE} = Rated V _{CEO} , I _B = 0)	I _{CEO}			100	μAdc
Collector Cutoff Current (V _{CE} = Rated V _{CEs} , V _{EB} = 0)	I _{CES}	@ T _C = 25°C		100	μAdc
		@ T _C = 125°C		1000	
Collector Base Current (V _{CB} = Rated V _{CBO} , V _{EB} = 0)	I _{CBO}	@ T _C = 25°C		100	μAdc
		@ T _C = 125°C		1000	
Emitter–Cutoff Current (V _{EB} = 9 Vdc, I _C = 0)	I _{EBO}			100	μAdc

ON CHARACTERISTICS

Base–Emitter Saturation Voltage (I _C = 5 Adc, I _B = 1 Adc)	@ T _C = 25°C	V _{BE(sat)}		1	1.1	Vdc
Collector–Emitter Saturation Voltage (I _C = 5 Adc, I _B = 1 Adc) (I _C = 7 Adc, I _B = 1.5 Adc)	@ T _C = 25°C	V _{CE(sat)}		0.37	0.6	Vdc
	@ T _C = 125°C			0.37	0.6	
	@ T _C = 25°C			0.5	0.75	Vdc
	@ T _C = 125°C			0.6	1.5	
DC Current Gain (I _C = 1 Adc, V _{CE} = 5 Vdc) (I _C = 5 Adc, V _{CE} = 5 Vdc) (I _C = 7 Adc, V _{CE} = 5 Vdc) (I _C = 10 Adc, V _{CE} = 5 Vdc)	@ T _C = 25°C	h _{FE}	15	24		—
	@ T _C = 125°C		16	28		
	@ T _C = 25°C		10	15		
	@ T _C = 125°C		10	14.5		
	@ T _C = 25°C		8	12		—
	@ T _C = 125°C		7	10.5		
	@ T _C = 25°C		6	9.5		—
	@ T _C = 125°C		4	8		

DYNAMIC SATURATION VOLTAGE

Dynamic Saturation Voltage: Determined 3 μs after rising I _{B1} reaches 90% of final I _{B1} (See Figure 19)	I _C = 5 Adc, I _{B1} = 1 Adc V _{CC} = 300 V	@ T _C = 25°C	V _{CE(dsat)}		1.1		V
		@ T _C = 125°C			2.1		V
	I _C = 7.5 Adc, I _{B1} = 1.5 Adc V _{CC} = 300 V	@ T _C = 25°C			1.7		V
		@ T _C = 125°C			5		V

DYNAMIC CHARACTERISTICS

Current Gain Bandwidth (I _C = 1 Adc, V _{CE} = 10 Vdc, f = 1 MHz)	f _T		23		MHz
Output Capacitance (V _{CB} = 10 Vdc, I _E = 0, f = 1 MHz)	C _{ob}		100	150	pF
Input Capacitance (V _{EB} = 8 Vdc, f = 1 MHz)	C _{ib}		1300	1750	pF

ELECTRICAL CHARACTERISTICS ($T_C = 25^\circ\text{C}$ unless otherwise noted)

Characteristic		Symbol	Min	Typ	Max	Unit
SWITCHING CHARACTERISTICS: Resistive Load (D.C. $\leq 10\%$, Pulse Width = 40 μs)						
Turn-on Time	$I_C = 1 \text{ Adc}, I_{B1} = 0.2 \text{ Adc}$ $I_{B2} = 0.2 \text{ Adc}$ $V_{CC} = 300 \text{ Vdc}$	@ $T_C = 25^\circ\text{C}$	t_{on}		130	ns
Turn-off Time		@ $T_C = 125^\circ\text{C}$			140	200
Turn-on Time	$I_C = 1 \text{ Adc}, I_{B1} = 0.2 \text{ Adc}$ $I_{B2} = 0.4 \text{ Adc}$ $V_{CC} = 300 \text{ Vdc}$	@ $T_C = 25^\circ\text{C}$	t_{off}		6.8	μs
Turn-off Time		@ $T_C = 125^\circ\text{C}$			8.5	8
Turn-on Time	$I_C = 1 \text{ Adc}, I_{B1} = 0.2 \text{ Adc}$ $I_{B2} = 0.4 \text{ Adc}$ $V_{CC} = 300 \text{ Vdc}$	@ $T_C = 25^\circ\text{C}$	t_{on}		140	ns
Turn-off Time		@ $T_C = 125^\circ\text{C}$			150	200
Turn-on Time	$I_C = 5 \text{ Adc}, I_{B1} = 1 \text{ Adc}$ $I_{B2} = 1 \text{ Adc}$ $V_{CC} = 300 \text{ Vdc}$	@ $T_C = 25^\circ\text{C}$	t_{off}		3.4	μs
Turn-off Time		@ $T_C = 125^\circ\text{C}$			4.3	4
Turn-on Time	$I_C = 5 \text{ Adc}, I_{B1} = 1 \text{ Adc}$ $I_{B2} = 1 \text{ Adc}$ $V_{CC} = 300 \text{ Vdc}$	@ $T_C = 25^\circ\text{C}$	t_{on}		250	ns
Turn-off Time		@ $T_C = 125^\circ\text{C}$			800	500
Turn-on Time	$I_C = 7.5 \text{ Adc}, I_{B1} = 1.5 \text{ Adc}$ $I_{B2} = 1.5 \text{ Adc}$ $V_{CC} = 300 \text{ Vdc}$	@ $T_C = 25^\circ\text{C}$	t_{off}		2.9	μs
Turn-off Time		@ $T_C = 125^\circ\text{C}$			3.6	3.5
Turn-on Time	$I_C = 7.5 \text{ Adc}, I_{B1} = 1.5 \text{ Adc}$ $I_{B2} = 1.5 \text{ Adc}$ $V_{CC} = 300 \text{ Vdc}$	@ $T_C = 25^\circ\text{C}$	t_{on}		500	ns
Turn-off Time		@ $T_C = 125^\circ\text{C}$			900	700
Turn-on Time	$I_C = 7.5 \text{ Adc}, I_{B1} = 1.5 \text{ Adc}$ $I_{B2} = 1.5 \text{ Adc}$ $V_{CC} = 300 \text{ Vdc}$	@ $T_C = 25^\circ\text{C}$	t_{off}		2.1	μs
Turn-off Time		@ $T_C = 125^\circ\text{C}$			2.5	2.5

SWITCHING CHARACTERISTICS: Inductive Load ($V_{clamp} = 300 \text{ V}, V_{CC} = 15 \text{ V}, L = 200 \mu\text{H}$)

Fall Time	$I_C = 1 \text{ Adc}$ $I_{B1} = 0.2 \text{ Adc}$ $I_{B2} = 0.2 \text{ Adc}$	@ $T_C = 25^\circ\text{C}$	t_{fi}		150	ns
Storage Time		@ $T_C = 125^\circ\text{C}$			180	250
Crossover Time		@ $T_C = 25^\circ\text{C}$	t_{si}		5.1	μs
Fall Time	$I_C = 1 \text{ Adc}$ $I_{B1} = 0.2 \text{ Adc}$ $I_{B2} = 0.5 \text{ Adc}$	@ $T_C = 125^\circ\text{C}$			5.8	6
Storage Time		@ $T_C = 25^\circ\text{C}$	t_c		230	ns
Crossover Time		@ $T_C = 125^\circ\text{C}$			300	325
Fall Time	$I_C = 1 \text{ Adc}$ $I_{B1} = 0.2 \text{ Adc}$ $I_{B2} = 0.5 \text{ Adc}$	@ $T_C = 25^\circ\text{C}$	t_{fi}		150	ns
Storage Time		@ $T_C = 125^\circ\text{C}$			170	250
Crossover Time		@ $T_C = 25^\circ\text{C}$	t_{si}		2.5	μs
Fall Time	$I_C = 1 \text{ Adc}$ $I_{B1} = 0.2 \text{ Adc}$ $I_{B2} = 0.5 \text{ Adc}$	@ $T_C = 125^\circ\text{C}$			2.8	3
Storage Time		@ $T_C = 25^\circ\text{C}$	t_c		260	ns
Crossover Time		@ $T_C = 125^\circ\text{C}$			300	350
Fall Time	$I_C = 5 \text{ Adc}$ $I_{B1} = 1 \text{ Adc}$ $I_{B2} = 1 \text{ Adc}$	@ $T_C = 25^\circ\text{C}$	t_{fi}		100	ns
Storage Time		@ $T_C = 125^\circ\text{C}$			140	150
Crossover Time		@ $T_C = 25^\circ\text{C}$	t_{si}		2.9	μs
Fall Time	$I_C = 5 \text{ Adc}$ $I_{B1} = 1 \text{ Adc}$ $I_{B2} = 1 \text{ Adc}$	@ $T_C = 125^\circ\text{C}$			4.6	3.5
Storage Time		@ $T_C = 25^\circ\text{C}$	t_c		220	ns
Crossover Time		@ $T_C = 125^\circ\text{C}$			450	300
Fall Time	$I_C = 7.5 \text{ Adc}$ $I_{B1} = 1.5 \text{ Adc}$ $I_{B2} = 1.5 \text{ Adc}$	@ $T_C = 25^\circ\text{C}$	t_{fi}		100	ns
Storage Time		@ $T_C = 125^\circ\text{C}$			150	150
Crossover Time		@ $T_C = 25^\circ\text{C}$	t_{si}		2	μs
Fall Time	$I_C = 7.5 \text{ Adc}$ $I_{B1} = 1.5 \text{ Adc}$ $I_{B2} = 1.5 \text{ Adc}$	@ $T_C = 125^\circ\text{C}$			2.5	2.5
Storage Time		@ $T_C = 25^\circ\text{C}$	t_c		250	ns
Crossover Time		@ $T_C = 125^\circ\text{C}$			475	350

TYPICAL STATIC CHARACTERISTICS

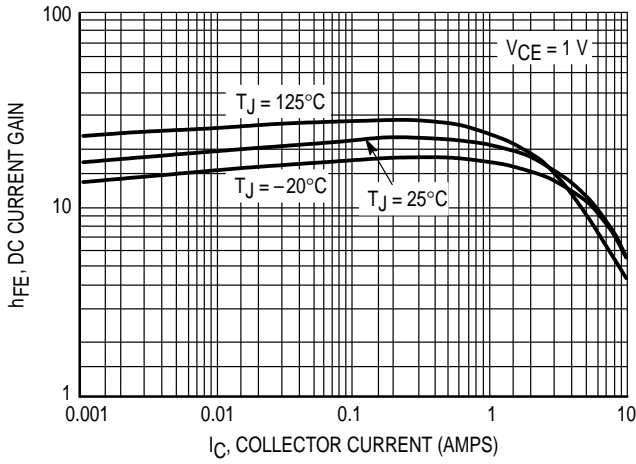

Figure 1. DC Current Gain @ 1 Volt

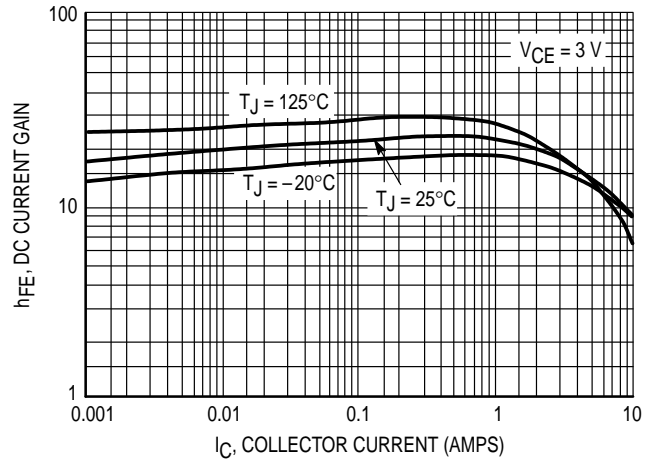

Figure 2. DC Current Gain @ 3 Volt

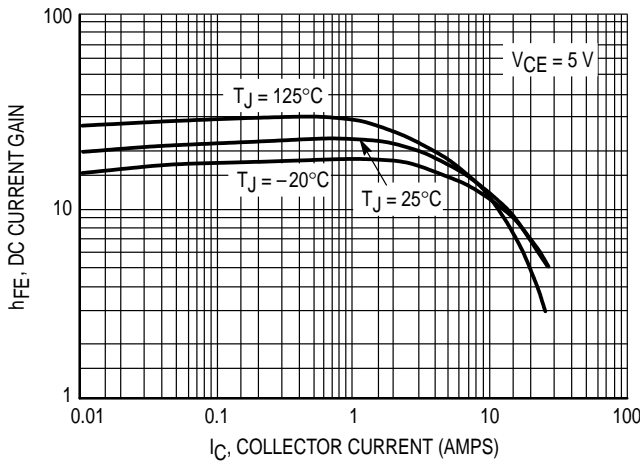

Figure 3. DC Current Gain @ 5 Volt

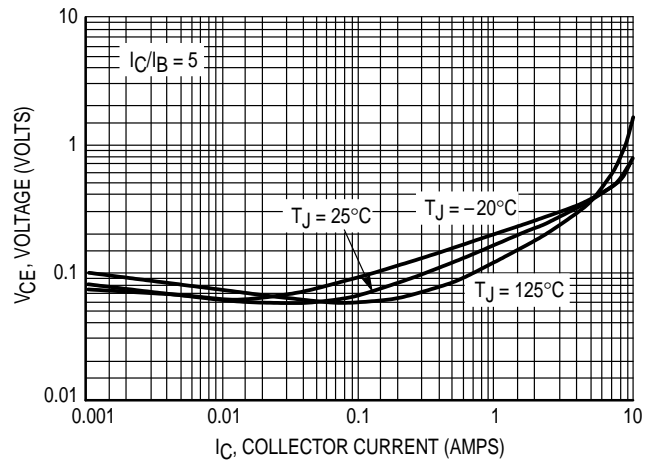

Figure 4. Collector-Emitter Saturation Voltage

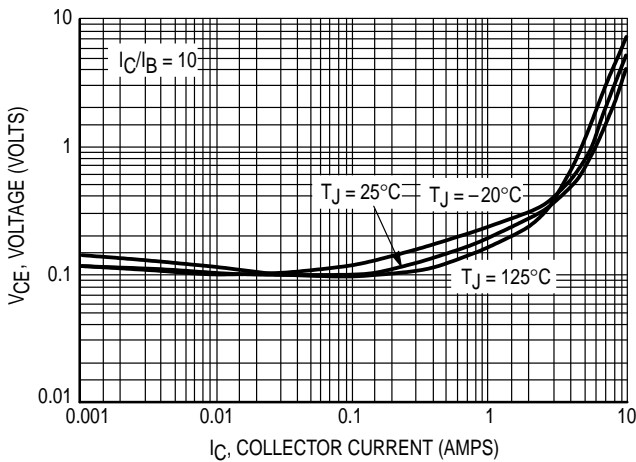

Figure 5. Collector-Emitter Saturation Voltage

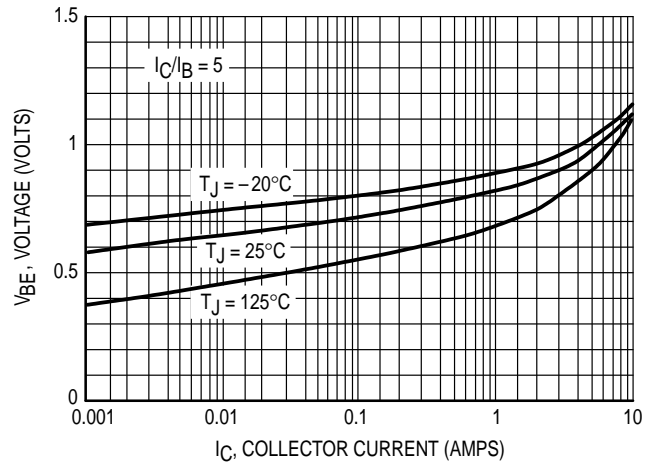

Figure 6. Base-Emitter Saturation Region

TYPICAL STATIC CHARACTERISTICS

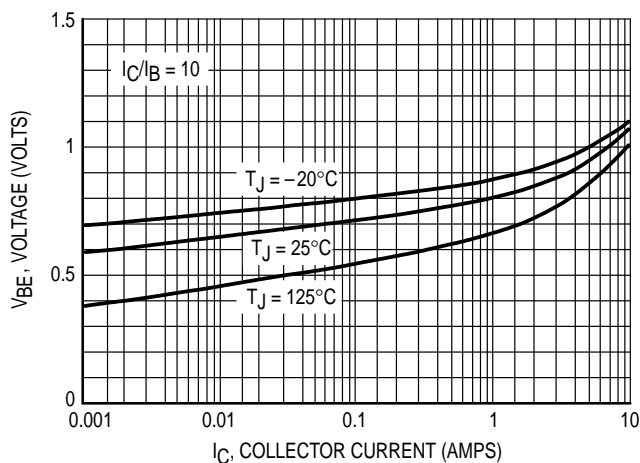

Figure 7. Base-Emitter Saturation Region

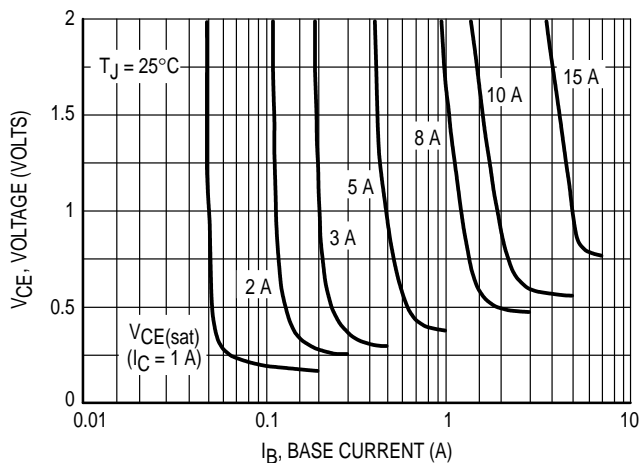

Figure 8. Collector Saturation Region

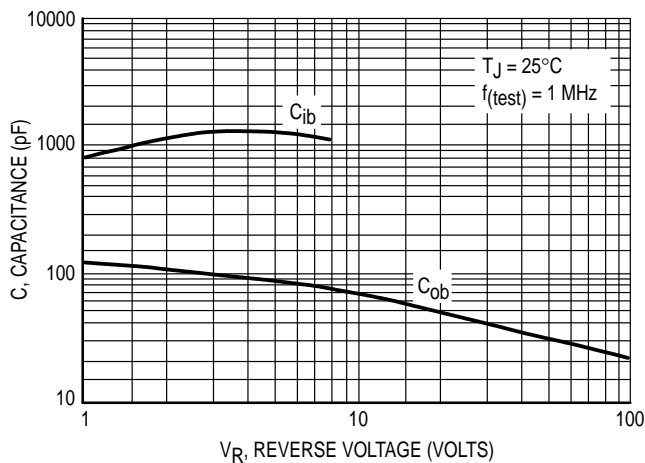

Figure 9. Capacitance

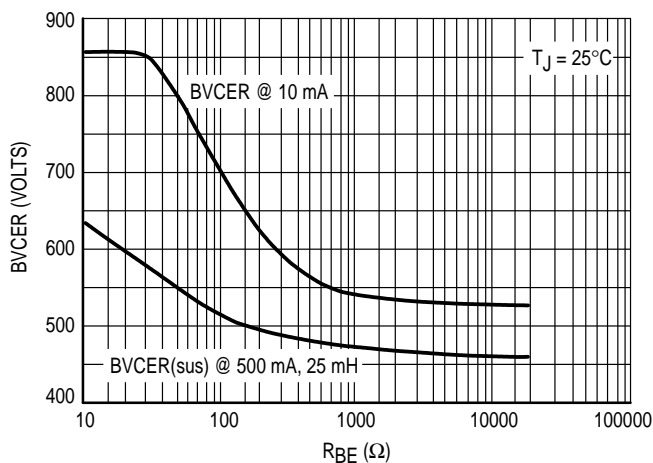

Figure 10. Resistive Breakdown

TYPICAL SWITCHING CHARACTERISTICS

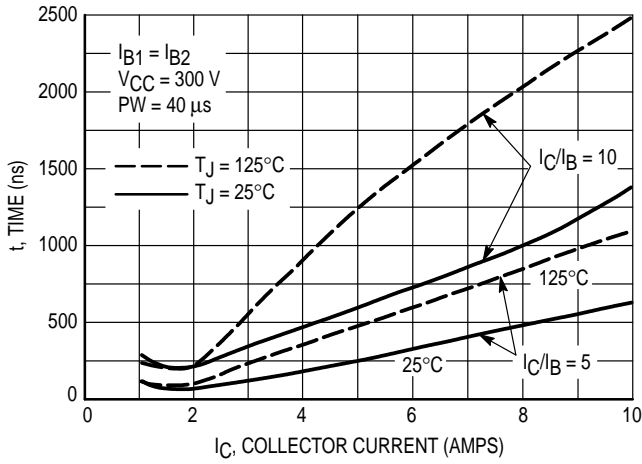

Figure 11. Resistive Switching Time, t_{on}

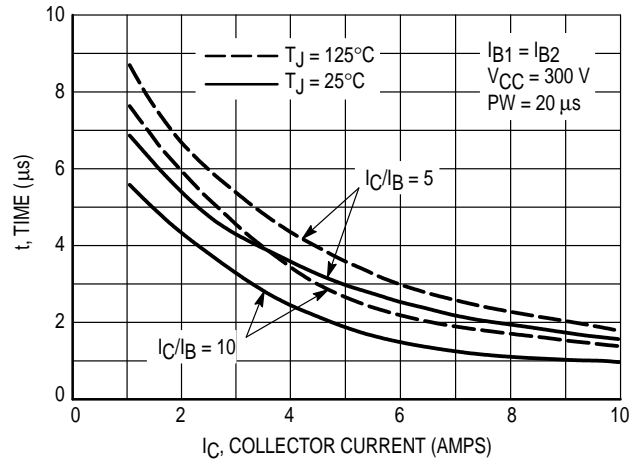

Figure 12. Resistive Switch Time, t_{off}

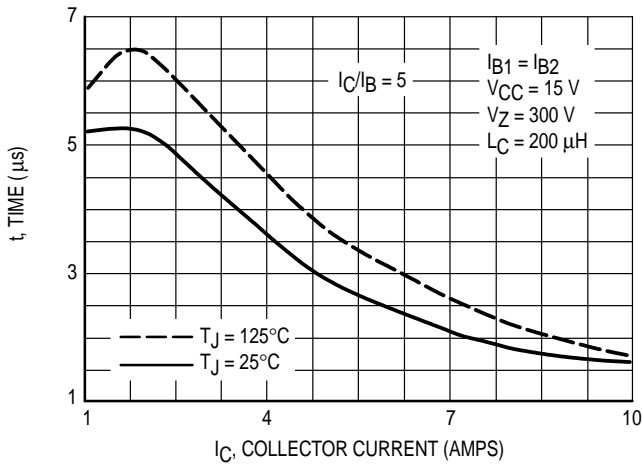

Figure 13. Inductive Storage Time, t_{si}

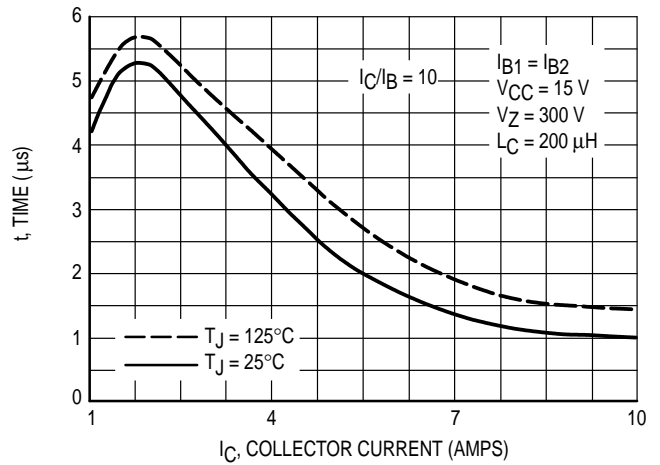

Figure 13 Bis. Inductive Storage Time, t_{si}

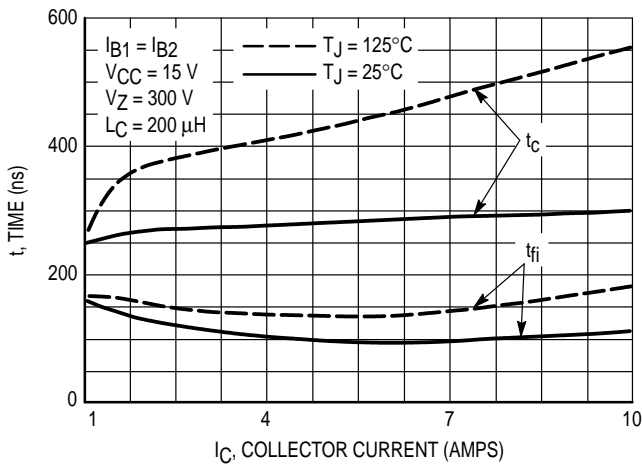

Figure 14. Inductive Storage Time, t_c & t_{fi} @ $I_C/I_B = 5$

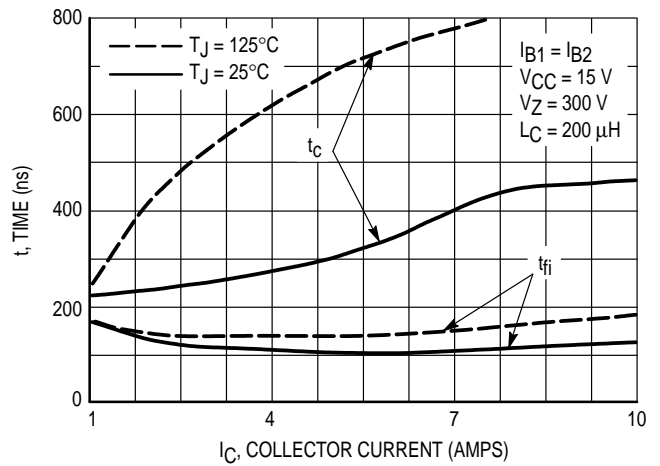

Figure 15. Inductive Storage Time, t_c & t_{fi} @ $I_C/I_B = 10$

TYPICAL SWITCHING CHARACTERISTICS

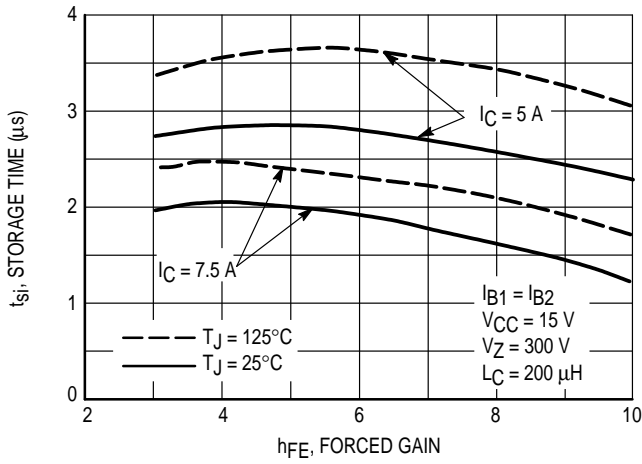

Figure 16. Inductive Storage Time

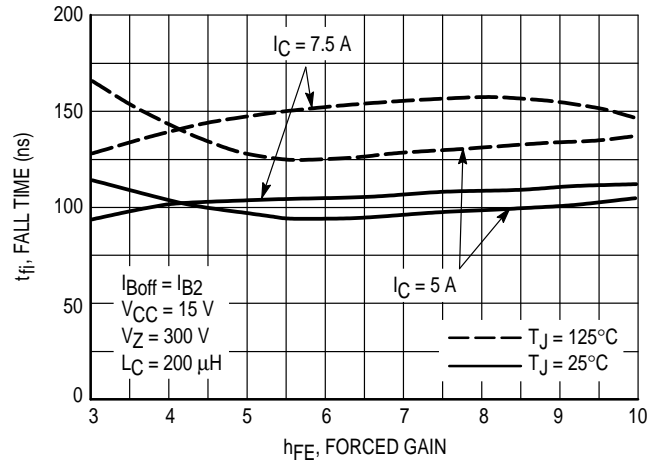

Figure 17. Inductive Fall Time

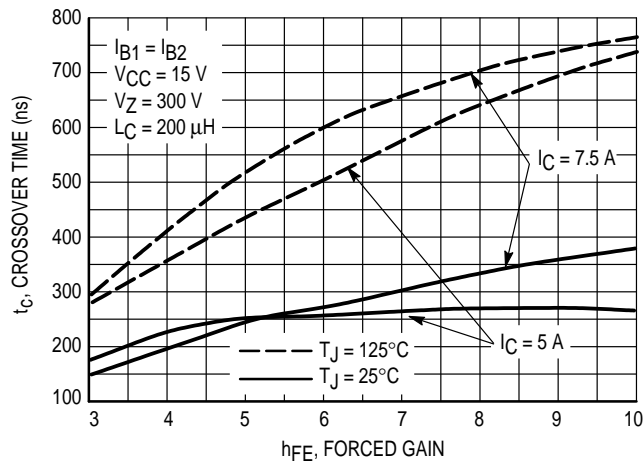

Figure 18. Inductive Crossover Time, t_c

TYPICAL SWITCHING CHARACTERISTICS

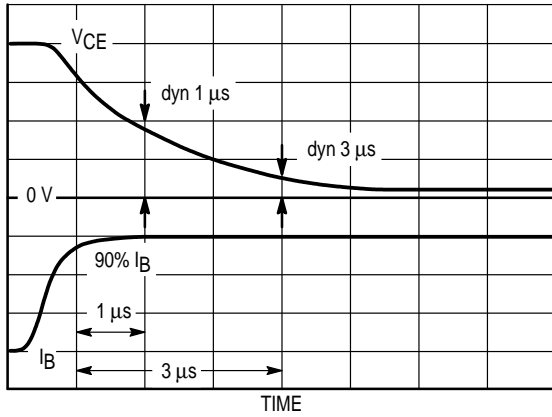

Figure 19. Dynamic Saturation Voltage Measurements

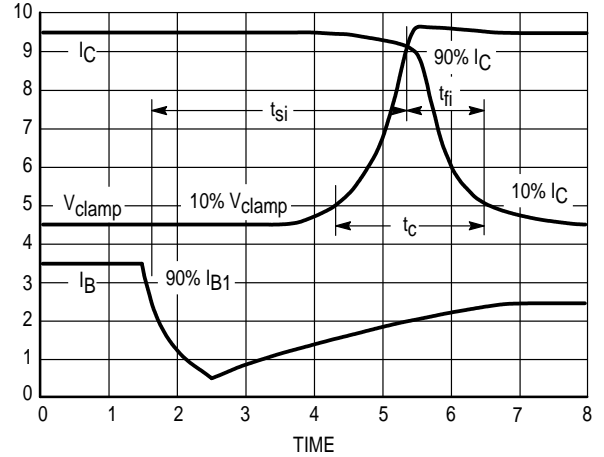
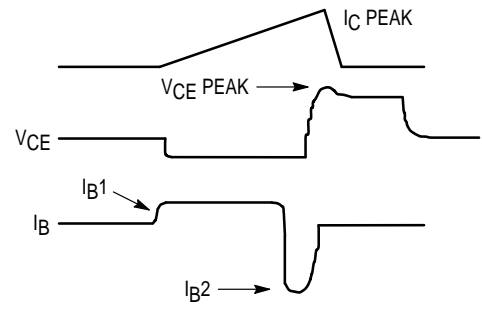
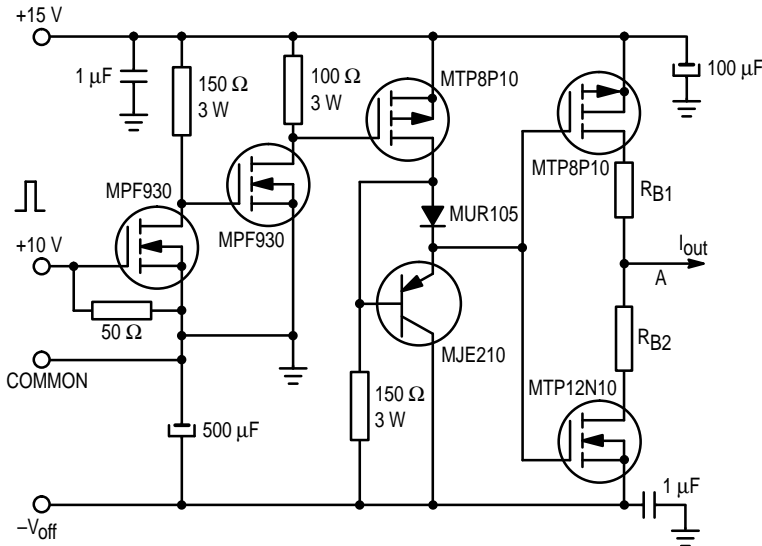

Figure 20. Inductive Switching Measurements

Table 1. Inductive Load Switching Drive Circuit



V(BR)CEO(sus)
 L = 10 mH
 RB2 = ∞
 VCC = 20 Volts
 IC(pk) = 100 mA

Inductive Switching
 L = 200 μH
 RB2 = 0
 VCC = 15 Volts
 RB1 selected for desired IB1

RBSOA
 L = 500 μH
 RB2 = 0
 VCC = 15 Volts
 RB1 selected for desired IB1

TYPICAL THERMAL RESPONSE

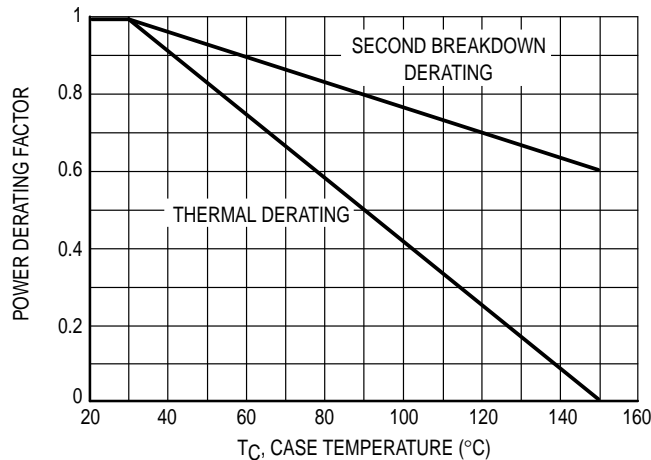

Figure 21. Forward Bias Power Derating

There are two limitations on the power handling ability of a transistor: average junction temperature and second breakdown. Safe operating area curves indicate I_C-V_{CE} limits of the transistor that must be observed for reliable operation; i.e., the transistor must not be subjected to greater dissipation than the curves indicate. The data of Figure 22 is based on $T_C = 25^\circ\text{C}$; $T_{J(pk)}$ is variable depending on power level. Second breakdown pulse limits are valid for duty cycles to 10% but must be derated when $T_C > 25^\circ\text{C}$. Second breakdown limitations do not derate the same as thermal limitations. Allowable current at the voltages shown on Figure 22 may be found at any case temperature by using the appropriate curve on Figure 21.

$T_{J(pk)}$ may be calculated from the data in Figure 24. At any case temperatures, thermal limitations will reduce the power that can be handled to values less than the limitations imposed by second breakdown. For inductive loads, high voltage and current must be sustained simultaneously during turn-off with the base to emitter junction reverse biased. The safe level is specified as a reverse biased safe operating area (Figure 23). This rating is verified under clamped conditions so that the device is never subjected to an avalanche mode.

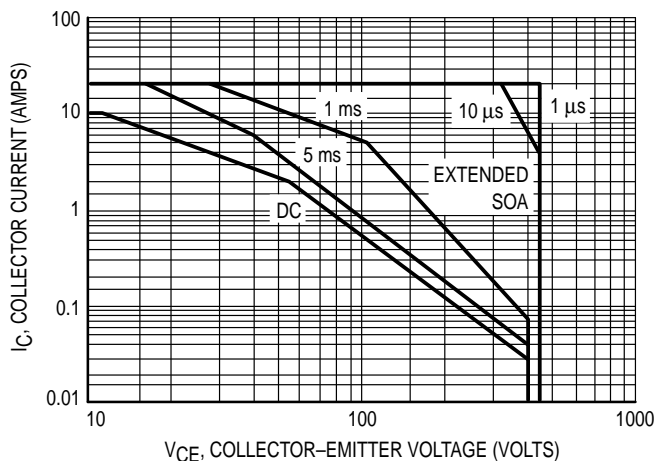

Figure 22. Forward Bias Safe Operating Area

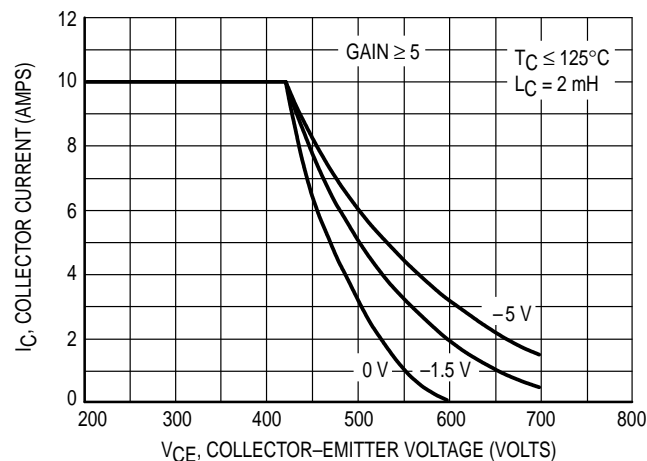

Figure 23. Reverse Bias Safe Operating Area

TYPICAL THERMAL RESPONSE

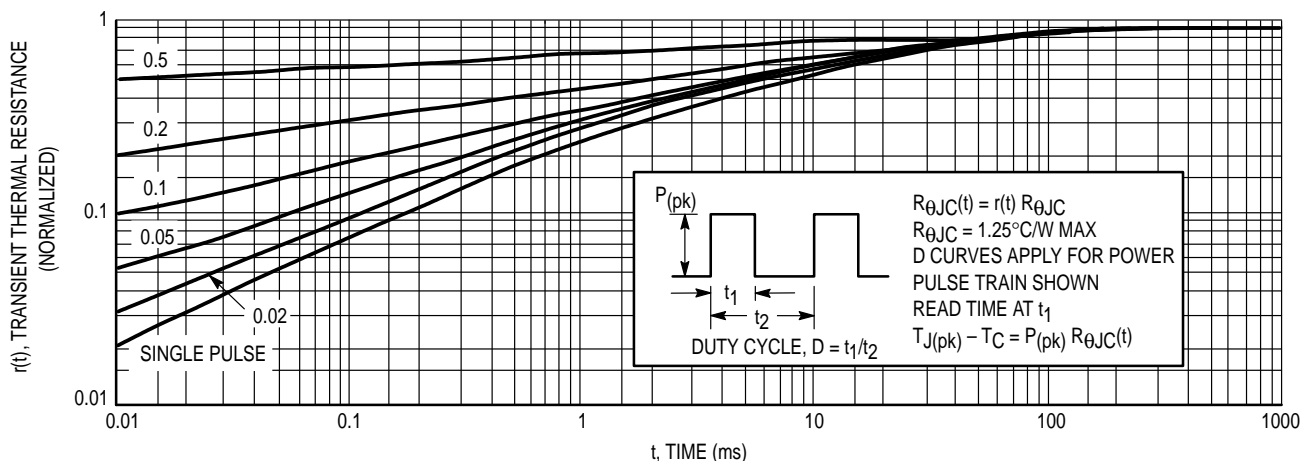
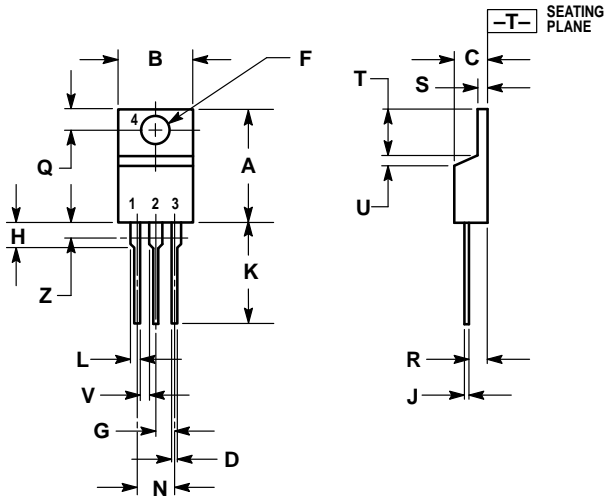

Figure 24. Typical Thermal Response ($Z_{\theta JC}(t)$) for BUH100

PACKAGE DIMENSIONS



- NOTES:
1. DIMENSIONING AND TOLERANCING PER ANSI Y14.5M, 1982.
 2. CONTROLLING DIMENSION: INCH.
 3. DIMENSION Z DEFINES A ZONE WHERE ALL BODY AND LEAD IRREGULARITIES ARE ALLOWED.

DIM	INCHES		MILLIMETERS	
	MIN	MAX	MIN	MAX
A	0.570	0.620	14.48	15.75
B	0.380	0.405	9.66	10.28
C	0.160	0.190	4.07	4.82
D	0.025	0.035	0.64	0.88
F	0.142	0.147	3.61	3.73
G	0.095	0.105	2.42	2.66
H	0.110	0.155	2.80	3.93
J	0.018	0.025	0.46	0.64
K	0.500	0.562	12.70	14.27
L	0.045	0.060	1.15	1.52
N	0.190	0.210	4.83	5.33
Q	0.100	0.120	2.54	3.04
R	0.080	0.110	2.04	2.79
S	0.045	0.055	1.15	1.39
T	0.235	0.255	5.97	6.47
U	0.000	0.050	0.00	1.27
V	0.045	—	1.15	—
Z	—	0.080	—	2.04

- STYLE 1:
1. BASE
 2. COLLECTOR
 3. EMITTER
 4. COLLECTOR

CASE 221A-06
TO-220AB
ISSUE Y

Motorola reserves the right to make changes without further notice to any products herein. Motorola makes no warranty, representation or guarantee regarding the suitability of its products for any particular purpose, nor does Motorola assume any liability arising out of the application or use of any product or circuit, and specifically disclaims any and all liability, including without limitation consequential or incidental damages. "Typical" parameters can and do vary in different applications. All operating parameters, including "Typicals" must be validated for each customer application by customer's technical experts. Motorola does not convey any license under its patent rights nor the rights of others. Motorola products are not designed, intended, or authorized for use as components in systems intended for surgical implant into the body, or other applications intended to support or sustain life, or for any other application in which the failure of the Motorola product could create a situation where personal injury or death may occur. Should Buyer purchase or use Motorola products for any such unintended or unauthorized application, Buyer shall indemnify and hold Motorola and its officers, employees, subsidiaries, affiliates, and distributors harmless against all claims, costs, damages, and expenses, and reasonable attorney fees arising out of, directly or indirectly, any claim of personal injury or death associated with such unintended or unauthorized use, even if such claim alleges that Motorola was negligent regarding the design or manufacture of the part. Motorola and are registered trademarks of Motorola, Inc. Motorola, Inc. is an Equal Opportunity/Affirmative Action Employer.

How to reach us:
USA / EUROPE: Motorola Literature Distribution;
 P.O. Box 20912; Phoenix, Arizona 85036. 1-800-441-2447

JAPAN: Nippon Motorola Ltd.; Tatsumi-SPD-JLDC, Toshikatsu Otsuki,
 6F Seibu-Butsuryu-Center, 3-14-2 Tatsumi Koto-Ku, Tokyo 135, Japan. 03-3521-8315

MFAX: RMFAX0@email.sps.mot.com - TOUCHTONE (602) 244-6609
INTERNET: http://Design-NET.com

HONG KONG: Motorola Semiconductors H.K. Ltd.; 8B Tai Ping Industrial Park,
 51 Ting Kok Road, Tai Po, N.T., Hong Kong. 852-26629298

