

### Overview

Raychem's families of PolySwitch resettable fuses continue to expand to include devices with wider voltage, current, and temperature ranges. Sixteen standard product families of PolySwitch devices are available in leaded, axial, and surface mount configurations. Many have received UL component recognition and meet the requirements of other agencies, including CSA and TÜV.

### PolySwitch devices are used in a wide variety of applications:

#### Automotive

- Actuators and medium motors
- Trace protection
- Wire harnesses

#### Battery Protection

- Lithium cells and battery packs
- Rechargeable battery packs
- Chargers

#### Computers and Peripherals

- DDC.2 computer video ports
- Hard disk drives/storage devices
- IEEE 1394 ports
- Mouse and keyboard ports
- USB (Universal Serial Bus) ports
- PC (PCMCIA) cards and sockets
- SCSI

#### Industrial

- MOSFET device protection
- Motors, fans, and blowers
- POS equipment
- Process and industrial controls
- Security and fire alarm systems
- Test and measurement equipment
- Transformers
- Medical electronics

#### Consumer

- Loudspeakers
- Satellite video receivers

### Telecommunications & Networking

- Customer premise equipment
- Primary protection: MDF modules, Network Interface Devices (NIDs)
- Analog modems, ISDN and xDSL equipment
- WAN, LAN, T1 Equipment
- Access network equipment, Central Office switches
- Cable power passing taps
- UL 1950, Telcordia GR-1089, GR-974 power fault protection
- ITU-T K.20, K.21, K.45 resistability requirements

### PolySwitch Resettable Fuses

#### Benefits:

- Reduced warranty and service costs
- Increased reliability
- Superior shock and vibration withstand
- Automated insertion
- Wide variety of applications

#### Features:

- Remotely resettable
- Testable
- Solid-state
- Tape and reel
- Variety of form factors
- Low resistance

#### What's New Inside:

- nanoSMD Products
- miniSMD Products
- RHE Products
- SRP Products
- VTP Products
- BBR Products
- Auto Products
- AHR
- AGR
- ASMD
- AHS

Standard PolySwitch product families include RGE, RHE, RTE, RUE, RXE, SMD, nanoSMD, microSMD, miniSMD, TS, BBR, TR, LR4, LTP, SRP, TAC, VTP, AHR, AGR, ASMD, and AHS devices. In addition, special devices, such as speaker devices (SPK), terminal devices (TD) and custom chip devices, can be manufactured to meet performance requirements that could be outside of the performance band of the standard products listed in this short-form catalog. Please contact a Raychem Circuit Protection Customer Service representative to discuss your special product needs.

60V

This product line can be used in a wide variety of automotive, computer and general electronics applications. The RGE devices feature high current carrying capability (up to 14 Amps) in a small package with fast trip times. The RHE devices can be used at temperatures up to 125°C.

Figure 1

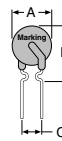

Lead size  
RXE010-090  
Ø 0.51 (0.020)  
24 AWG

Figure 2

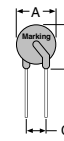

Lead size  
RXE110-375  
Ø 0.81 (0.032)  
20 AWG

Part number	I <sub>H</sub> * (A)	V max. (V)	I max.** (A)	R <sub>1</sub> max. (Ω)	Agency recognition	Dimensions (millimeters/inches)			Fig.
						A (max.)	B (max.)	C (max.)	
RXE010	0.10	60	40	7.50	UL, TÜV, CSA	7.4 (0.29)	11.6 (0.46)	5.08 (0.20)	1
RXE017	0.17	60	40	8.00	UL, TÜV, CSA	7.4 (0.29)	12.7 (0.50)	5.08 (0.20)	1
RXE020	0.20	72	40	4.40	UL, TÜV, CSA	7.4 (0.29)	11.7 (0.46)	5.08 (0.20)	1
RXE025	0.25	72	40	3.00	UL, TÜV, CSA	7.4 (0.29)	12.7 (0.50)	5.08 (0.20)	1
RXE030	0.30	72	40	2.10	UL, TÜV, CSA	7.4 (0.29)	12.7 (0.50)	5.08 (0.20)	1
RXE040	0.40	72	40	1.29	UL, TÜV, CSA	7.6 (0.30)	13.5 (0.53)	5.08 (0.20)	1
RXE050	0.50	72	40	1.17	UL, TÜV, CSA	7.9 (0.31)	13.7 (0.54)	5.08 (0.20)	1
RXE065	0.65	72	40	0.72	UL, TÜV, CSA	9.4 (0.37)	14.5 (0.57)	5.08 (0.20)	1
RXE075	0.75	72	40	0.60	UL, TÜV, CSA	10.2 (0.40)	15.0 (0.59)	5.08 (0.20)	1
RXE090	0.90	72	40	0.47	UL, TÜV, CSA	11.2 (0.44)	15.8 (0.62)	5.08 (0.20)	1
RXE110	1.10	72	40	0.38	UL, TÜV, CSA	12.8 (0.50)	17.5 (0.69)	5.08 (0.20)	2
RXE135	1.35	72	40	0.30	UL, TÜV, CSA	14.5 (0.57)	19.1 (0.75)	5.08 (0.20)	2
RXE160	1.60	72	40	0.22	UL, TÜV, CSA	16.3 (0.64)	20.8 (0.82)	5.08 (0.20)	2
RXE185	1.85	72	40	0.19	UL, TÜV, CSA	17.5 (0.69)	22.2 (0.88)	5.08 (0.20)	2
RXE250	2.50	72	40	0.13	UL, TÜV, CSA	20.8 (0.82)	28.4 (1.00)	10.2 (0.40)	2
RXE300	3.00	72	40	0.10	UL, TÜV, CSA	23.9 (0.94)	28.6 (1.13)	10.2 (0.40)	2
RXE375	3.75	72	40	0.08	UL, TÜV, CSA	27.2 (1.07)	31.8 (1.25)	10.2 (0.40)	2

\*Hold current 20°C.

\*\*Device may withstand higher interrupt current at lower voltages. Each application will need to be individually evaluated.

33V

Figure 3



Lead size  
Ø 0.51 (0.020)  
24 AWG

Part number	I <sub>H</sub> * (A)	V max. (Vdc)	I max.** (A)	R <sub>1</sub> max. (Ω)	Agency*** recognition	Dimensions (millimeters/inches)			Fig.
						A (max.)	B (max.)	C (nom.)	
RTE120	1.20	33	40	0.180	UL, TÜV	7.4 (0.29)	12.2 (0.48)	5.08 (0.20)	3
RTE135	1.35	33	40	0.143	UL, TÜV	7.4 (0.29)	14.2 (0.56)	5.08 (0.20)	3
RTE190	1.90	33	40	0.092	UL, TÜV	8.9 (0.35)	13.5 (0.53)	5.08 (0.20)	3

\*Hold current 20°C.

\*\*Device may withstand higher interrupt current at lower voltages. Each application will need to be individually evaluated.

\*\*\*CSA is pending for RTE devices.

30V

Figure 4



Lead size  
RUE090-250  
Ø 0.51 (0.020)  
24 AWG

Figure 5

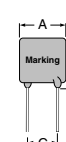

Lead size  
RUE300-900  
Ø 0.81 (0.032)  
20 AWG

Part number	I <sub>H</sub> * (A)	V max. (Vdc)	I max.** (A)	R <sub>1</sub> max. (Ω)	Agency recognition	Dimensions (millimeters/inches)			Fig.
						A (max.)	B (max.)	C (nom.)	
RUE090	0.90	30	40	0.22	UL, TÜV, CSA	7.4 (0.29)	12.2 (0.48)	5.08 (0.20)	4
RUE110	1.10	30	40	0.17	UL, TÜV, CSA	7.4 (0.29)	14.2 (0.56)	5.08 (0.20)	4
RUE135	1.35	30	40	0.13	UL, TÜV, CSA	8.9 (0.35)	13.5 (0.53)	5.08 (0.20)	4
RUE160	1.60	30	40	0.11	UL, TÜV, CSA	8.9 (0.35)	15.2 (0.60)	5.08 (0.20)	4
RUE185	1.85	30	40	0.09	UL, TÜV, CSA	10.2 (0.40)	15.7 (0.62)	5.08 (0.20)	4
RUE250	2.50	30	40	0.07	UL, TÜV, CSA	11.4 (0.45)	18.3 (0.72)	5.08 (0.20)	4
RUE300	3.00	30	40	0.08	UL, TÜV, CSA	11.4 (0.45)	17.3 (0.68)	5.08 (0.20)	5
RUE400	4.00	30	40	0.05	UL, TÜV, CSA	14.0 (0.55)	20.1 (0.79)	5.08 (0.20)	5
RUE500	5.00	30	40	0.05	UL, TÜV, CSA	14.0 (0.55)	24.9 (0.98)	10.2 (0.40)	5
RUE600	6.00	30	40	0.04	UL, TÜV, CSA	16.5 (0.65)	24.9 (0.98)	10.2 (0.40)	5
RUE700	7.00	30	40	0.03	UL, TÜV, CSA	19.1 (0.75)	26.7 (1.05)	10.2 (0.40)	5
RUE800	8.00	30	40	0.02	UL, TÜV, CSA	21.6 (0.85)	29.2 (1.15)	10.2 (0.40)	5
RUE900	9.00	30	40	0.02	UL, TÜV, CSA	24.1 (0.95)	29.7 (1.17)	10.2 (0.40)	5

\*Hold current 20°C.

\*\*Device may withstand higher interrupt current at lower voltages. Each application will need to be individually evaluated.

16V High Temperature

Figure 6

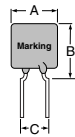

Lead size  
RHE450-1000  
Ø 0.81 (0.032)  
20 AWG

Lead size  
RHE1300  
Ø 1.0 (0.04)  
18 AWG

Figure 7

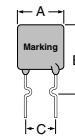

Lead size  
RHE070  
Ø 0.51 (0.020)  
24 AWG

Part number	I <sub>H</sub> * (A)	V max. (Vdc)	I max.** (A)	R <sub>1</sub> max. (Ω)	Agency recognition	Dimensions (millimeters/inches)			Fig.
						A (max.)	B (max.)	C (nom.)	
RHE070	0.7	16	40	0.80	UL, TÜV, CSA	6.86 (0.27)	10.8 (0.425)	5.08 (0.20)	7
RHE450	4.5	16	100	0.054	UL, TÜV, CSA	10.4 (0.41)	15.6 (0.61)	5.08 (0.20)	6
RHE600	6.0	16	100	0.032	UL, TÜV, CSA	11.2 (0.44)	21.0 (0.83)	5.08 (0.20)	6
RHE650	6.5	16	100	0.026	UL, TÜV, CSA	12.7 (0.50)	22.2 (0.88)	5.08 (0.20)	6
RHE750	7.5	16	100	0.022	UL, TÜV, CSA	14.0 (0.55)	23.5 (0.93)	5.08 (0.20)	6
RHE1000	10.0	16	100	0.015	UL, TÜV, CSA	17.5 (0.69)	26.5 (1.04)	10.2 (0.40)	6
RHE1300	13.0	16	100	0.010	UL, TÜV, CSA	23.5 (0.925)	28.7 (1.13)	10.2 (0.40)	6

\*Hold current 25°C.

\*\*Device may withstand higher interrupt current at lower voltages. Each application will need to be individually evaluated.

16V

Figure 8

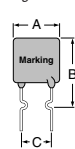

Lead size  
RUSB090-250  
Ø 0.51 (0.020)  
24 AWG

Figure 9

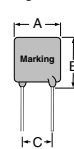

Lead size  
RGE300-RGE1100  
Ø 0.81 (0.032)  
20 AWG

Lead size  
RGE1200-RGE1400  
Ø 1.0 (0.04)  
18 AWG

Part number	I <sub>H</sub> (A)	V max. (V)	I max.** (A)	R <sub>1</sub> max. (Ω)	Agency recognition	Dimensions (millimeters/inches)			Fig.
						A (max.)	B (max.)	C (nom.)	
RUSB090*	0.90	16	40	0.18	UL, TÜV, CSA	7.4 (0.29)	12.2 (0.48)	5.08 (0.20)	8
RUSB110*	1.10	16	40	0.14	UL, TÜV, CSA	7.4 (0.29)	14.2 (0.56)	5.08 (0.20)	8
RUSB135*	1.35	16	40	0.115	UL, TÜV, CSA	8.9 (0.35)	13.5 (0.53)	5.08 (0.20)	8
RUSB160*	1.60	16	40	0.11	UL, TÜV, CSA	8.9 (0.35)	15.2 (0.60)	5.08 (0.20)	8
RUSB185*	1.85	16	40	0.09	UL, TÜV, CSA	10.2 (0.40)	15.7 (0.62)	5.08 (0.20)	8
RUSB250*	2.5	16	40	0.06	UL, TÜV, CSA	11.4 (0.45)	18.3 (0.72)	5.08 (0.20)	8
RGE300	3.0	16	100	0.098	UL, TÜV, CSA	7.1 (0.28)	11.0 (0.43)	5.08 (0.20)	9
RGE400	4.0	16	100	0.060	UL, TÜV, CSA	8.9 (0.35)	12.8 (0.50)	5.08 (0.20)	9
RGE500	5.0	16	100	0.034	UL, TÜV, CSA	10.4 (0.41)	14.3 (0.56)	5.08 (0.20)	9
RGE600	6.0	16	100	0.028	UL, TÜV, CSA	10.7 (0.42)	17.1 (0.67)	5.08 (0.20)	9
RGE700	7.0	16	100	0.022	UL, TÜV, CSA	11.2 (0.44)	19.7 (0.78)	5.08 (0.20)	9
RGE800	8.0	16	100	0.0175	UL, TÜV, CSA	12.7 (0.50)	20.9 (0.82)	5.08 (0.20)	9
RGE900	9.0	16	100	0.0135	UL, TÜV, CSA	14.0 (0.55)	21.7 (0.85)	5.08 (0.20)	9
RGE1000	10.0	16	100	0.0102	UL, TÜV, CSA	16.5 (0.65)	25.2 (0.99)	5.08 (0.20)	9
RGE1100	11.0	16	100	0.0089	UL, TÜV, CSA	17.5 (0.69)	26.0 (1.02)	5.08 (0.20)	9
RGE1200	12.0	16	100	0.0086	UL, TÜV, CSA	17.5 (0.69)	28.0 (1.10)	10.2 (0.40)	9
RGE1400	14.0	16	100	0.0064	UL, TÜV, CSA	23.5 (0.925)	27.9 (1.10)	10.2 (0.40)	9

\*Hold current 20°C.

\*\*Device may withstand higher interrupt current at lower voltages. Each application will need to be individually evaluated.

6V

Figure 10

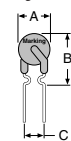

Lead size  
RUSB-6V products  
Ø 0.51 (0.020)  
24 AWG

Part number	I <sub>H</sub> * (A)	V max. (Vdc)	I max.** (A)	R <sub>1</sub> max. (Ω)	Agency recognition	Dimensions (millimeters/inches)			Fig.
						A (max.)	B (max.)	C (nom.)	
RUSB075	0.75	6	40	0.23	UL, TÜV, CSA	6.9 (0.27)	11.4 (0.45)	5.08 (0.20)	10
RUSB120	1.20	6	40	0.14	UL, TÜV, CSA	6.9 (0.27)	11.7 (0.46)	5.08 (0.20)	10
RUSB155	1.55	6	40	0.10	UL, TÜV, CSA	6.9 (0.27)	11.7 (0.46)	5.08 (0.20)	10

\*Hold current 20°C.

\*\*Device may withstand higher interrupt current at lower voltages. Each application will need to be individually evaluated.

These product lines consist of radial leaded and surface mount devices that protect against short duration high voltage faults (250-600Vrms). TR and TS products are designed to meet the protection needs of telecommunications applications. BBR devices provide overcurrent protection of the power tap in hybrid-coaxial applications.

TR, TS and BBR devices are not intended for continuous utility line voltage operation (i.e. 120v or 240V).

Figure 1

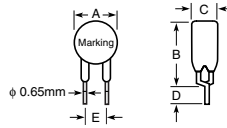
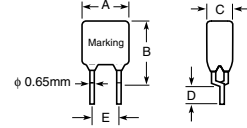

Figure 2



**TR250**

Part number	I <sub>H</sub> (A)	V max. (V <sub>rms</sub> )	I max. (A)	R min. (Ω)	R max. (Ω)	R <sub>1</sub> max. (Ω)	Agency recognition	Fig.
TR250-080T	0.080	250	3.0	15.0	22.0	33.0	UL, TÜV, CSA	1
TR250-080U	0.080	250	3.0	14.0	20.0	33.0	UL, TÜV, CSA	1
TR250-110U	0.110	250	3.0	5.0	9.0	16.0	UL, TÜV, CSA	1
TR250-120	0.120	250	3.0	4.0	8.0	16.0	UL, TÜV, CSA	2
TR250-120T	0.120	250	3.0	7.0	12.0	16.0	UL, TÜV, CSA	2
TR250-120T-RA	0.120	250	3.0	7.0	9.0	16.0	UL, TÜV, CSA	2
TR250-120T-RC	0.130	250	3.0	5.4	7.5	14.0	UL, TÜV, CSA	2
TR250-120T-RF	0.120	250	3.0	6.0	10.5	16.0	UL, TÜV, CSA	2
TR250-120T-R1	0.120	250	3.0	6.0	9.0	16.0	UL, TÜV, CSA	2
TR250-120T-R2	0.120	250	3.0	8.0	10.5	16.0	UL, TÜV, CSA	2
TR250-120U	0.120	250	3.0	6.0	10.0	16.0	UL, TÜV, CSA	2
TR250-120UT	0.120	250	3.0	7.0	12.0	16.0	UL, TÜV, CSA	2
TR250-145	0.145	250	3.0	3.0	6.0	14.0	UL, TÜV, CSA	2
TR250-145-RA	0.145	250	3.0	3.0	5.5	12.0	UL, TÜV, CSA	2
TR250-145-RB	0.145	250	3.0	4.5	6.0	12.0	UL, TÜV, CSA	2
TR250-145T	0.145	250	3.0	5.4	7.5	14.0	UL, TÜV, CSA	2
TR250-145U	0.145	250	3.0	3.5	6.5	12.0	UL, TÜV, CSA	2
TR250-180U	0.180	250	10.0	0.8	2.0	4.0	UL, TÜV, CSA	2

\*These products are intended for telecom applications. Please see the Raychem Circuit Protection Databook for application details. Products are available in binned versions for resistance-matched applications. See Raychem Circuit Protection Databook for performance details.

Part number	Dimensions (millimeters/inches)					Fig.
	A (max.)	B (max.)	C (max.)	D (min.)	E (typ.)	
TR250-080T	5.30 (0.209)	9.9 (0.390)	3.80 (0.15)	4.7 (0.185)	5.00 (0.197)	1
TR250-080U	4.80 (0.189)	9.3 (0.366)	3.80 (0.15)	4.7 (0.185)	5.00 (0.197)	1
TR250-110U	5.33 (0.210)	9.4 (0.370)	3.80 (0.15)	4.7 (0.185)	5.00 (0.197)	1
TR250-120	6.50 (0.256)	11.0 (0.433)	4.60 (0.18)	4.7 (0.185)	5.00 (0.197)	2
TR250-120U	6.00 (0.236)	10.0 (0.394)	3.80 (0.15)	4.7 (0.185)	5.00 (0.197)	2
TR250-145	6.50 (0.256)	11.0 (0.433)	4.60 (0.18)	4.7 (0.185)	5.00 (0.197)	2
TR250-145U	6.00 (0.236)	10.0 (0.394)	3.80 (0.15)	4.7 (0.185)	5.00 (0.197)	2
TR250-180U	10.40 (0.410)	12.6 (0.495)	3.60 (0.14)	4.7 (0.185)	5.00 (0.197)	2

**TS250**

Figure 3

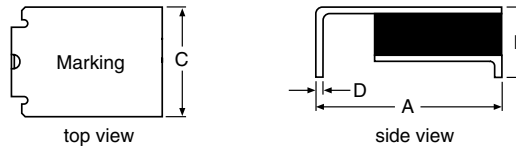

Part number	I <sub>H</sub> (A)	V max. (V <sub>rms</sub> )	I max. (A)	R min. (Ω)	R max. (Ω)	R <sub>1</sub> max. (Ω)	Agency recognition	Fig.
TS250-130	0.130	250/(650)	3.0/(1.1)	6.5	12.0	20.0	UL, TÜV, CSA	3
TS250-130-RA	0.130	250/(650)	3.0/(1.1)	6.5	9.0	20.0	UL, TÜV, CSA	3
TS250-130-RB	0.130	250/(650)	3.0/(1.1)	9.0	12.0	20.0	UL, TÜV, CSA	3
TS250-130-RC-B-0.5	0.130	250/(650)	3.0/(1.1)	7.0	10.0	20.0	UL, TÜV, CSA	3

\*These products are intended for telecom applications. Please see the Raychem Circuit Protection Databook for application details.

Part number	Dimensions (millimeters/inches)			Fig.
	A (max.)	B (max.)	C (max.)	
TS250-130	9.4 (0.370)	3.4 (0.135)	7.4 (0.290)	3
TS250-130-RA	9.4 (0.370)	3.4 (0.135)	7.4 (0.290)	3
TS250-130-RB	9.4 (0.370)	3.4 (0.135)	7.4 (0.290)	3
TS250-130-RC-B-0.5	9.4 (0.370)	3.4 (0.135)	7.4 (0.290)	3

TR600

Figure 4

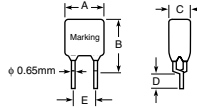

Part number	I <sub>H</sub> (A)	V max. (V <sub>rms</sub> )	I max. (A)	R min. (Ω)	R max. (Ω)	R <sub>1</sub> max. (Ω)	Agency recognition	Fig.
TR600-150	0.150	600	3.0	6.0	12.0	22.0	UL, CSA	4
TR600-150-RA	0.150	600	3.0	7.0	10.0	20.0	UL, CSA	4
TR600-150-RB	0.150	600	3.0	9.0	12.0	22.0	UL, CSA	4
TR600-160	0.160	600	3.0	4.0	10.0	18.0	UL, CSA	4
TR600-160-RA	0.160	600	3.0	4.0	7.0	16.0	UL, CSA	4
TR600-160-R1	0.160	600	3.0	4.0	8.0	17.0	UL, CSA	4

\*These products are intended for telecom applications. Please see the Raychem Circuit Protection Databook for application details. Products are available in binned versions for resistance-matched applications. See Raychem Circuit Protection Databook for performance details.

Dimensions (millimeters/inches)

Part number	A (max.)	B (max.)	C (max.)	D (min.)	E (max.)	Fig.
TR600-150	13.50 (0.531)	12.6 (0.496)	6.00 (0.236)	4.7 (0.185)	5.00 (0.197)	4
TR600-160	16.00 (0.630)	12.6 (0.496)	6.00 (0.236)	4.7 (0.185)	5.00 (0.197)	4

TS600

Figure 5

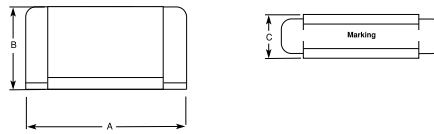

Part number	I <sub>H</sub> (A)	V max. (V <sub>rms</sub> )	I max. (A)	R min. (Ω)	R max. (Ω)	R <sub>1</sub> max. (Ω)	Agency recognition	Fig.
TS600-170	0.170	600	3.0	4.0	9.0	18.0	UL, CSA	5
TS600-200-RA-B-0.5	0.200	600	3.0	4.0	7.5	13.5	UL, CSA	5

\*These products are intended for telecom applications. Please see the Raychem Circuit Protection Databook for application details.

Dimensions (millimeters/inches)

Part number	A (max.)	B (max.)	C (max.)	Fig.
TS600-170	19.43 (0.765)	12.32 (0.485)	8.26 (0.325)	5
TS600-200-RA-B-0.5	19.43 (0.765)	12.32 (0.485)	8.26 (0.325)	5

BBR

Figure 6

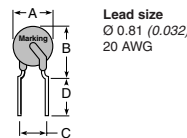

Part number	I <sub>H</sub> (A)	V max. (rms)	I max. (A)	R min. (Ω)	R max. (Ω)	R <sub>1</sub> max. (Ω)	Agency recognition	Fig.
<b>New</b> BBR550	0.55	90	20	0.45	0.90	1.5	UL, CSA	6
<b>New</b> BBR750	0.75	90	20	0.40	0.75	1.2	UL, CSA	6

\*These products are intended for telecom applications. Please see the Raychem Circuit Protection Databook for application details.

Dimensions (millimeters/inches)

Part number	A (max.)	B (max.)	C (nom.)	D (min.)	Fig.
<b>New</b> BBR550	10.9 (0.43)	14.0 (0.55)	5.08 (0.2)	7.6 (0.3)	6
<b>New</b> BBR750	11.9 (0.47)	15.5 (0.61)	5.08 (0.2)	7.6 (0.3)	6

This product line is designed for surface-mount applications. The variety of sizes enables installation in limited space applications such as crowded printed circuit boards, digital cameras, PC cards, subnotebook computers, computer peripheral equipment, and general electronics. These devices are designed for applications where such space is constrained and resettable circuit protection is desired.

Figure 1

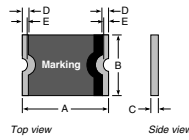

Figure 2

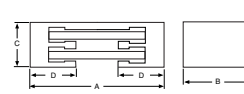
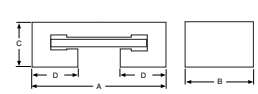

Figure 3



**nanoSMD Size: 3216 (mm), 1206 (mils)**

Part number	I <sub>H</sub> * (A)	V max. (Vdc)	I max. (A)	R <sub>Typ</sub> (Ω)	R <sub>1</sub> max. (Ω)	Agency recognition	Dimensions (millimeters/inches)					Fig.
							A (max.)	B (max.)	C (max.)	D (min.)		
<b>Coming Soon</b> nanoSMDM050	0.50	6	40	0.40	0.70	pending	3.4 (0.134)	1.8 (0.071)	1.2 (0.048)	0.75 (0.030)	3	
<b>Coming Soon</b> nanoSMDM075	0.75	6	40	0.20	0.29	pending	3.4 (0.134)	1.8 (0.071)	1.2 (0.048)	0.75 (0.030)	3	
<b>Coming Soon</b> nanoSMDM100	1.00	6	40	0.11	0.21	pending	3.4 (0.134)	1.8 (0.071)	1.2 (0.048)	0.75 (0.030)	3	
<b>Preliminary</b> nanoSMDC150	1.50	6	40	0.08	0.11	pending	3.4 (0.134)	1.8 (0.071)	1.22 (0.050)	0.25 (0.010)	1	

**microSMD Size: 3225 (mm), 1210 (mils)**

Part number	I <sub>H</sub> * (A)	V max. (Vdc)	I max. (A)	R <sub>Typ</sub> (Ω)	R <sub>1</sub> max. (Ω)	Agency recognition	Dimensions (millimeters/inches)					Fig.
							A (max.)	B (max.)	C (max.)	D (min.)	E (min.)	
microSMD005	0.05	30	10	25.00	50.0	UL, TÜV, CSA	3.43 (0.135)	2.80 (0.111)	0.85 (0.034)	0.30 (0.012)	0.25 (0.010)	1
microSMD035	0.35	6	40	0.81	1.300	UL, TÜV, CSA	3.43 (0.135)	2.80 (0.111)	0.62 (0.025)	0.30 (0.012)	0.25 (0.010)	1
microSMD050	0.50	13.2	40	0.55	0.900	UL, TÜV, CSA	3.43 (0.135)	2.80 (0.111)	0.62 (0.025)	0.25 (0.10)	0.20 (0.008)	1
microSMD075	0.75	6	40	0.29	0.400	UL, TÜV, CSA	3.43 (0.135)	2.80 (0.111)	0.62 (0.025)	0.25 (0.10)	0.20 (0.008)	1
microSMD110	1.10	6	40	0.14	0.210	UL, TÜV, CSA	3.43 (0.135)	2.80 (0.111)	0.48 (0.019)	0.25 (0.10)	0.20 (0.008)	1
<b>New</b> microSMD150	1.50	6	40	0.07	0.110	UL, TÜV, CSA	3.43 (0.135)	2.80 (0.111)	1.22 (0.048)	0.30 (0.012)	0.25 (0.010)	1

**miniSMD Size: 4532 (mm), 1812 (mils)**

Part number	I <sub>H</sub> * (A)	V max. (Vdc)	I max. (A)	R <sub>Typ</sub> (Ω)	R <sub>1</sub> max. (Ω)	Agency recognition	Dimensions (millimeters/inches)					Fig.
							A (max.)	B (max.)	C (max.)	D (min.)	E (min.)	
miniSMDC014	0.14	60	10	4.0	6.000	UL, TÜV, CSA	4.73 (0.186)	3.41 (0.134)	0.89 (0.035)	0.30 (0.012)	0.25 (0.01)	1
miniSMDC020	0.20	30	10	1.4	3.300	UL, TÜV, CSA	4.73 (0.186)	3.41 (0.134)	0.89 (0.035)	0.30 (0.012)	0.25 (0.01)	1
miniSMDC050	0.50	15	40	0.60	3.300	UL, TÜV, CSA	4.73 (0.186)	3.41 (0.134)	0.62 (0.025)	0.30 (0.012)	0.25 (0.01)	1
miniSMDC075	0.75	13.2	40	0.26	0.450	UL, TÜV, CSA	4.73 (0.186)	3.41 (0.134)	0.62 (0.025)	0.30 (0.012)	0.25 (0.01)	1
miniSMDM075	0.75	13.2	40	0.20	0.300	UL, TÜV, CSA	4.75 (0.187)	3.60 (0.142)	2.00 (0.079)	1.4 (0.055)	—	2
miniSMDM075/24	0.75	24	40	0.20	0.290	UL, TÜV, CSA	4.75 (0.187)	3.60 (0.142)	2.00 (0.079)	1.4 (0.055)	—	2
miniSMDC110	1.10	6	40	0.12	0.210	UL, TÜV, CSA	4.73 (0.186)	3.41 (0.134)	0.62 (0.025)	0.30 (0.012)	0.25 (0.01)	1
miniSMDM110	1.10	8	40	0.12	0.180	UL, TÜV, CSA	4.75 (0.187)	3.60 (0.142)	2.00 (0.079)	1.4 (0.055)	—	2
miniSMDM110/16	1.10	16	40	0.12	0.180	UL, TÜV, CSA	4.75 (0.187)	3.60 (0.142)	2.00 (0.079)	1.4 (0.055)	—	2
miniSMDC125	1.25	6	40	0.09	0.140	UL, TÜV, CSA	4.73 (0.186)	3.41 (0.134)	0.48 (0.019)	0.25 (0.010)	0.20 (0.008)	1
miniSMDC150	1.50	6	40	0.07	0.110	UL, TÜV, CSA	4.73 (0.186)	3.41 (0.134)	0.48 (0.019)	0.25 (0.010)	0.20 (0.008)	1
miniSMDM160	1.60	8	40	0.066	0.099	UL, TÜV, CSA	4.75 (0.187)	3.60 (0.142)	2.00 (0.079)	1.4 (0.055)	—	2
miniSMDC200	2.00	6	40	0.050	0.070	UL, TÜV, CSA	4.73 (0.186)	3.41 (0.134)	1.22 (0.048)	0.30 (0.012)	0.25 (0.01)	1
miniSMDM200	2.00	8	40	0.040	0.060	UL, TÜV, CSA	4.75 (0.187)	3.60 (0.142)	2.00 (0.079)	1.4 (0.055)	—	2
miniSMDC260	2.60	6	40	0.035	0.047	UL, TÜV, CSA	4.73 (0.186)	3.41 (0.134)	1.25 (0.050)	0.30 (0.012)	0.25 (0.01)	1
<b>New</b> miniSMDM260	2.60	8	40	0.030	0.043	UL, TÜV, CSA	4.75 (0.187)	3.60 (0.142)	2.00 (0.079)	1.4 (0.055)	—	2

**miniSMD Size: 11550 (mm), 4420 (mils)**

Part number	I <sub>H</sub> * (A)	V max. (Vdc)	I max. (A)	R <sub>Typ</sub> (Ω)	R <sub>1</sub> max. (Ω)	Agency recognition	Dimensions (millimeters/inches)					Fig.
							A (max.)	B (max.)	C (max.)	D (min.)	E (min.)	
miniSMDE190	1.90	16	100	0.065	0.08	UL, TÜV, CSA	11.51 (0.453)	5.33 (0.210)	0.53 (0.021)	0.51 (0.020)	—	1

\*Hold current, 20°C.

This product line is also designed for surface mount applications. The products range in hold currents from 0.3 Amps to 3.0 Amps and voltages from 6 Volts to 60 Volts. These devices are suited for high-density board applications in computer and computer peripheral products, telecommunications, and general electronics applications. They are designed to be reflowed onto a printed circuit board using standard surface mount processes.

Figure 4

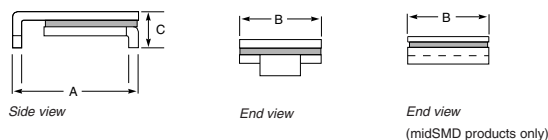

midSMD

Part number	I <sub>H</sub> <sup>+</sup> (A)	V max. (Vdc)	I max. (A)	R <sub>Typ</sub> (Ω)	R <sub>1</sub> max. (Ω)	Dimensions (millimeters/inches)				Fig.
						Agency recognition	A (max.)	B (max.)	C (max.)	
SMD030-2018	0.3	60	20	1.40	2.30	UL, TÜV, CSA	5.44 (0.214)	4.93 (0.194)	1.78 (0.07)	4
SMD100-2018	1.10	15	40	0.25	0.400	UL, TÜV, CSA	5.44 (0.214)	4.93 (0.194)	1.52 (0.06)	4
SMD150-2018	1.50	15	40	0.13	0.180	UL, TÜV, CSA	5.44 (0.214)	4.93 (0.194)	1.52 (0.06)	4
SMD200-2018	2.00	6	40	0.07	0.100	UL, TÜV, CSA	5.44 (0.214)	4.93 (0.194)	1.52 (0.06)	4

SMD

Part number	I <sub>H</sub> <sup>+</sup> (A)	V max. (Vdc)	I max. (A)	R <sub>Typ</sub> (Ω)	R <sub>1</sub> max. (Ω)	Dimensions (millimeters/inches)				Fig.
						Agency recognition	A (max.)	B (max.)	C (max.)	
SMD030	0.30	60	10	3.0	4.800	UL, TÜV, CSA	7.9 (0.31)	5.4 (0.21)	3.2 (0.125)	4
SMD050	0.50	60	10	0.87	1.400	UL, TÜV, CSA	7.9 (0.31)	5.4 (0.21)	3.2 (0.125)	4
SMD075	0.75	30	40	0.67	1.000	UL, TÜV, CSA	7.9 (0.31)	5.4 (0.21)	3.2 (0.125)	4
SMD100	1.10	30	40	0.30	0.480	UL, TÜV, CSA	7.9 (0.31)	5.4 (0.21)	3.0 (0.118)	4
SMD100/33	1.10	33	40	0.27	0.410	UL, TÜV, CSA	7.9 (0.31)	5.4 (0.21)	3.0 (0.118)	4
SMD125	1.25	15	40	0.16	0.250	UL, TÜV, CSA	7.9 (0.31)	5.4 (0.21)	3.0 (0.118)	4
SMD260	2.60	6	40	0.05	0.075	UL, TÜV, CSA	7.9 (0.31)	5.4 (0.21)	3.0 (0.118)	4
SMD260-RB	2.60	6	40	0.055	0.075	UL, TÜV, CSA	7.9 (0.31)	5.4 (0.21)	3.0 (0.118)	4
SMD300	3.00	6	40	0.033	0.048	UL, TÜV, CSA	7.9 (0.31)	5.4 (0.21)	3.0 (0.118)	4

SMD2

Part number	I <sub>H</sub> <sup>+</sup> (A)	V max. (Vdc)	I max. (A)	R <sub>Typ</sub> (Ω)	R <sub>1</sub> max. (Ω)	Dimensions (millimeters/inches)				Fig.
						Agency recognition	A (max.)	B (max.)	C (max.)	
SMD150	1.50	15	40	0.16	0.250	UL, TÜV, CSA	9.4 (0.370)	6.6 (0.26)	3.00 (0.118)	4
SMD150/33	1.50	33	40	0.15	0.230	UL, TÜV, CSA	9.4 (0.370)	6.6 (0.26)	3.00 (0.118)	4
SMDH160	1.60	16	70	0.10	0.150	UL, TÜV, CSA	9.4 (0.370)	6.6 (0.26)	3.00 (0.118)	4
SMD185	1.85	33	40	0.12	0.150	UL, TÜV, CSA	9.4 (0.370)	6.71 (0.264)	3.00 (0.118)	4
SMD200	2.00	15	40	0.09	0.125	UL, TÜV, CSA	9.4 (0.370)	6.71 (0.264)	3.00 (0.118)	4
SMD250	2.50	15	40	0.06	0.085	UL, TÜV, CSA	9.4 (0.370)	6.71 (0.264)	3.00 (0.118)	4

VTP: 90°C Activation

The conductive polymer composite in the VTP battery overcurrent protection devices provides increased safety with extended battery run time. These devices reach a high-resistance state at lower temperatures in NiMH and rechargeable lithium temperature-sensitive chemistries.

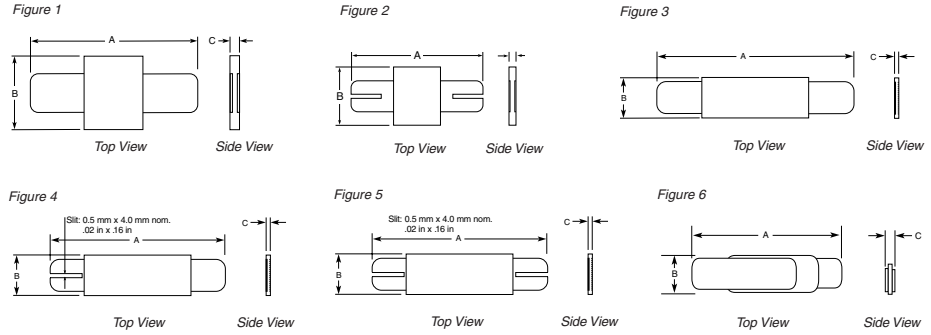

Part number	I <sub>H</sub> <sup>+</sup> (A)	V max. (Vdc)	I max. (A)	R max. initial (Ω)	Agency recognition	Dimensions (millimeters/inches)			Fig.
						A (max.)	B (max.)	C (max.)	
New VTP170	1.7	16	100	0.052	UL, TÜV, CSA	17.5 (0.689)	7.4 (0.292)	0.8 (0.03)	1
New VTP170SS	1.7	16	100	0.052	UL, TÜV, CSA	17.5 (0.689)	7.4 (0.292)	0.8 (0.03)	2
VTP170X	1.7	16	100	0.052	UL, TÜV, CSA	22.9 (0.90)	5.3 (0.21)	0.8 (0.03)	3
New VTP170XS	1.7	16	100	0.052	UL, TÜV, CSA	22.9 (0.90)	5.3 (0.21)	0.8 (0.03)	3
New VTP175L	1.75	16	100	0.051	UL	28.0 (1.10)	3.9 (0.15)	0.8 (0.03)	3
New VTP175U	1.75	16	100	0.051	UL	23.2 (0.91)	3.7 (0.15)	0.7 (0.03)	3
New VTP200G	2.0	16	100	0.039	UL, TÜV, CSA	23.1 (0.91)	4.5 (0.18)	0.8 (0.03)	3
VTP200U	2.0	16	100	0.039	UL, TÜV, CSA	23.1 (0.91)	4.3 (0.17)	0.7 (0.03)	6
VTP210G	2.1	16	100	0.030	UL, TÜV, CSA	23.1 (0.91)	5.3 (0.21)	0.8 (0.03)	3
New VTP210GU	2.1	16	100	0.030	UL, TÜV, CSA	23.2 (0.91)	5.1 (0.20)	0.8 (0.03)	6
VTP210L	2.1	16	100	0.030	UL, TÜV, CSA	26.0 (1.02)	5.3 (0.21)	0.8 (0.03)	3
VTP210S	2.1	16	100	0.030	UL, TÜV, CSA	23.1 (0.91)	5.3 (0.21)	0.8 (0.03)	4
VTP210SL	2.1	16	100	0.030	UL, TÜV, CSA	32.0 (1.26)	5.3 (0.21)	0.8 (0.03)	4
New VTP210SL-19.2/5.8	2.1	16	100	0.030	UL, TÜV, CSA	37.0 (1.46)	5.3 (0.21)	0.8 (0.03)	4
VTP210SS	2.1	16	100	0.030	UL, TÜV, CSA	23.1 (0.91)	5.3 (0.21)	0.8 (0.03)	5
New VTP210ULD	2.1	16	100	0.030	UL, TÜV, CSA	25.2 (1.00)	5.1 (0.20)	0.8 (0.03)	6
New VTP240	2.4	16	100	0.026	CSA UL, (TÜV pending)	26.2 (1.03)	5.3 (0.21)	0.8 (0.03)	3

LTP, miniSMDE, TAC: 110°C Activation

LTP and TAC devices provide reliable, noncycling protection for rechargeable batteries. LTP devices also offer additional protection at elevated temperatures. The TAC devices' unique cap design makes them easy to install directly on AAA size battery cells.

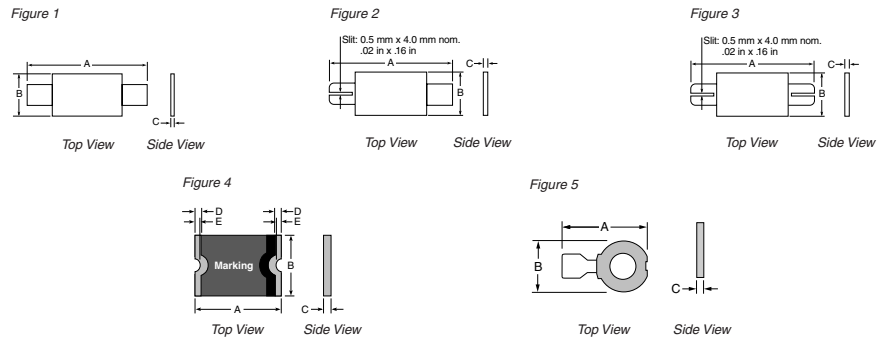

Part number	I <sub>H</sub> <sup>+</sup> (A)	V max. (Vdc)	I max. (A)	R max. initial (Ω)	Agency recognition	Dimensions (millimeters/inches)			Fig.
						A (max.)	B (max.)	C (max.)	
<b>LTP</b>									
LTP070	0.7	15	100	0.20	UL, TÜV, CSA	22.1 (0.87)	5.2 (0.20)	1.2 (0.048)	1
LTP070S	0.7	15	100	0.20	UL, TÜV, CSA	22.1 (0.87)	5.2 (0.20)	1.2 (0.048)	2
LTP100	1.0	24	100	0.130	UL, TÜV, CSA	23.1 (0.91)	5.2 (0.20)	1.0 (0.04)	1
LTP100S	1.0	24	100	0.130	UL, TÜV, CSA	23.1 (0.91)	5.2 (0.20)	1.0 (0.04)	2
LTP100SL	1.0	24	100	0.130	UL, TÜV, CSA	32.0 (1.26)	5.2 (0.20)	1.0 (0.04)	2
LTP100SS	1.0	24	100	0.130	UL, TÜV, CSA	23.1 (0.91)	5.2 (0.20)	1.0 (0.04)	3
LTP180	1.8	24	100	0.068	UL, TÜV, CSA	26.0 (1.02)	5.2 (0.20)	1.0 (0.04)	1
LTP180L	1.8	24	100	0.068	UL, TÜV, CSA	37.5 (1.48)	5.2 (0.20)	1.0 (0.04)	1
LTP180S	1.8	24	100	0.068	UL, TÜV, CSA	26.0 (1.02)	5.2 (0.20)	1.0 (0.04)	2
LTP190	1.9	24	100	0.057	UL, TÜV, CSA	23.4 (0.92)	11.0 (0.43)	1.1 (0.04)	1
LTP260	2.6	24	100	0.042	UL, TÜV, CSA	26.0 (1.02)	11.9 (0.47)	1.0 (0.04)	1
LTP300	3.0	24	100	0.031	UL, TÜV, CSA	31.8 (1.25)	13.5 (0.53)	1.1 (0.04)	1
LTP340	3.4	24	100	0.027	UL, TÜV, CSA	26.0 (1.02)	15.9 (0.63)	1.0 (0.04)	1
<b>miniSMDE</b>									
miniSMDE190	1.9	16	100	0.040	UL, TÜV, CSA	11.51 (0.453)	5.33 (0.21)	0.53 (0.021)	4
<b>TAC</b>									
TAC100-09	1.0	15	50	0.155	UL	17.5 (0.69)	10.5 (0.45)	0.9 (0.04)	5



**LR4, SRP, TAC: 120°C Activation**

The LR4 devices' smaller thermal mass means reduced reaction time to overcurrent events. The LR4 devices are suited for battery packs intended for computer and camcorder applications. The SRP products provide reliable, noncycling protection for rechargeable batteries. Weldable nickel leads and a narrow, low-profile design make these devices easy to install directly onto battery cells.

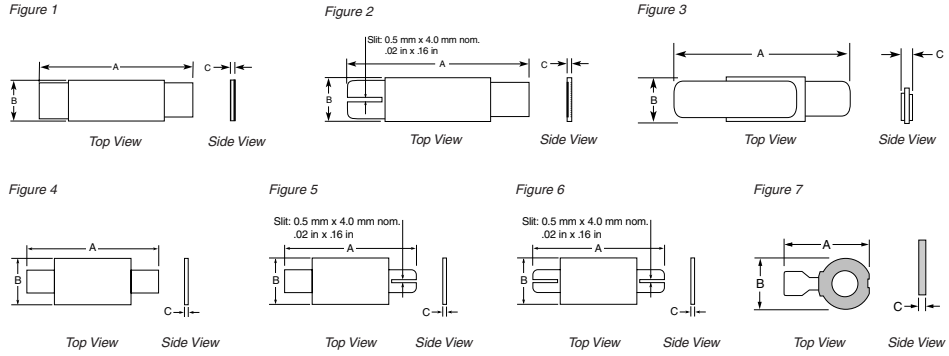

Part number	I <sub>H</sub> * (A)	V max. (Vdc)	I max. (A)	R max. initial (Ω)	Agency recognition	Dimensions (millimeters/inches)			
						A (max.)	B (max.)	C (max.)	Fig.
<b>LR4</b>									
LR4-170U	1.7	15	100	0.078	Pending	21.0 (0.83)	4.0 (0.16)	0.7 (0.03)	3
LR4-190	1.9	15	100	0.072	UL, TÜV, CSA	22.1 (0.87)	5.5 (0.22)	1.0 (0.04)	1
LR4-190S	1.9	15	100	0.072	UL, TÜV, CSA	22.1 (0.87)	5.5 (0.22)	1.0 (0.04)	2
LR4-260	2.6	15	100	0.042	UL, TÜV, CSA	23.1 (0.91)	5.5 (0.22)	1.0 (0.04)	1
LR4-260S	2.6	15	100	0.042	UL, TÜV, CSA	23.1 (0.91)	5.5 (0.22)	1.0 (0.04)	2
LR4-380	3.8	15	100	0.026	UL, TÜV, CSA	26.0 (1.02)	7.5 (0.30)	1.0 (0.04)	1
LR4-450	4.5	20	100	0.020	UL, TÜV, CSA	26.0 (1.02)	10.5 (0.41)	1.0 (0.04)	1
LR4-550	5.5	20	100	0.016	UL, TÜV, CSA	37.0 (1.46)	7.5 (0.30)	1.0 (0.04)	1
LR4-600	6.0	20	100	0.014	UL, TÜV, CSA	26.0 (1.02)	14.5 (0.57)	1.0 (0.04)	1
LR4-730	7.3	20	100	0.012	UL, TÜV, CSA	29.1 (1.15)	14.5 (0.57)	1.0 (0.04)	1
<b>SRP</b>									
SRP120	1.2	15	100	0.160	UL, TÜV, CSA	22.1 (0.87)	5.2 (0.20)	1.0 (0.04)	4
<b>New</b> SRP120L	1.2	15	100	0.160	UL, TÜV, CSA	27.1 (1.07)	5.2 (0.20)	1.0 (0.04)	4
SRP120S	1.2	15	100	0.160	UL, TÜV, CSA	22.1 (0.87)	5.2 (0.20)	1.0 (0.04)	5
SRP175	1.75	15	100	0.090	UL, TÜV, CSA	23.1 (0.91)	5.2 (0.20)	1.0 (0.04)	4
<b>New</b> SRP175L	1.75	15	100	0.090	UL, TÜV, CSA	32.1 (1.26)	5.2 (0.20)	1.0 (0.04)	4
SRP175S	1.75	15	100	0.090	UL, TÜV, CSA	23.1 (0.91)	5.2 (0.20)	1.0 (0.04)	5
SRP175SS	1.75	15	100	0.090	UL, TÜV, CSA	23.1 (0.91)	5.2 (0.20)	1.0 (0.04)	6
SRP200	2.0	30	100	0.060	UL, TÜV, CSA	23.4 (0.92)	11.0 (0.43)	1.1 (0.04)	4
SRP350	3.5	30	100	0.031	UL, TÜV, CSA	31.8 (1.25)	13.5 (0.53)	1.1 (0.04)	4
SRP420	4.2	30	100	0.024	UL, TÜV, CSA	32.4 (1.28)	13.6 (0.54)	1.1 (0.04)	4
<b>TAC</b>									
TAC170-09	1.7	15	50	0.098	UL	17.5 (0.69)	10.5 (0.42)	0.9 (0.04)	7
TAC210	2.1	15	50	0.062	UL, TÜV, CSA	17.5 (0.69)	10.5 (0.42)	0.9 (0.04)	7

These product lines are qualified to operate in Automotive environments and are compliant with QS-9000 AEC and Raychem Circuit Protection specified PS400.

Figure 1

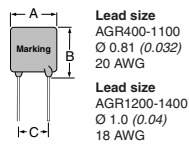

Figure 2

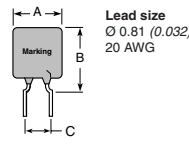
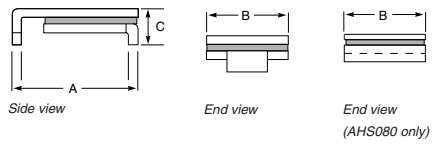

Figure 3



**AGR: Radial Leaded**

Part number	$I_H^*$ (A) $R_1$ max.	$I_H^*$ (A) $R_2$ max.	V max. (Vdc)	I max. (A)	R min. ( $\Omega$ )	$R_1$ max. ( $\Omega$ )	$R_2$ max. ( $\Omega$ )	Dimensions (millimeters/inches)			Fig.
								A (max.)	B (max.)	C (typ.)	
New AGR400	4.0	3.0	16	100	0.0186	0.061	0.085	8.9 (0.35)	14.1 (0.56)	5.08 (0.2)	1
New AGR500	5.0	4.3	16	100	0.0140	0.034	0.048	10.4 (0.41)	15.6 (0.61)	5.08 (0.2)	1
New AGR600	6.0	5.3	16	100	0.0095	0.028	0.032	10.7 (0.42)	18.4 (0.73)	5.08 (0.2)	1
New AGR700	7.0	6.5	16	100	0.0066	0.020	0.022	11.2 (0.44)	21.0 (0.83)	5.08 (0.2)	1
New AGR800	8.0	7.6	16	100	0.0049	0.0175	0.0181	12.7 (0.50)	22.2 (0.88)	5.08 (0.2)	1
New AGR900	9.0	8.6	16	100	0.0041	0.0135	0.0140	14.0 (0.55)	23.0 (0.91)	5.08 (0.2)	1
New AGR1000	10.0	9.6	16	100	0.0034	0.0102	0.0106	16.51 (0.65)	25.7 (1.01)	5.08 (0.2)	1
New AGR1100	11.0	10.5	16	100	0.0033	0.0089	0.0093	17.5 (0.69)	26.5 (1.04)	5.08 (0.2)	1
New AGR1200	12.0	11.5	16	100	0.0030	0.0086	0.0091	17.5 (0.69)	28.8 (1.14)	10.2 (0.4)	1
New AGR1400	14.0	13.0	16	100	0.0022	0.0064	0.0067	23.5 (0.925)	28.7 (1.13)	10.2 (0.4)	1

**AHR: High Temp Radial Leaded**

Part number	$I_H^*$ (A) $R_1$ max.	$I_H^*$ (A) $R_2$ max.	V max. (Vdc)	I max. (A)	R min. ( $\Omega$ )	$R_1$ max. ( $\Omega$ )	$R_2$ max. ( $\Omega$ )	Dimensions (millimeters/inches)			Fig.
								A (max.)	B (max.)	C (typ.)	
New AHR450	4.5	4.5	16	100	0.0170	0.054	0.054	10.4 (0.41)	15.6 (0.61)	5.08 (0.2)	2
New AHR600	6.0	6.0	16	100	0.0100	0.032	0.032	11.2 (0.44)	21.0 (0.83)	5.08 (0.2)	2
New AHR650	6.5	6.5	16	100	0.009	0.026	0.026	12.7 (0.50)	22.2 (0.88)	5.08 (0.2)	2
New AHR750	7.5	7.5	16	100	0.0074	0.022	0.022	14.0 (0.55)	23.5 (0.93)	5.08 (0.2)	2
New AHR1000	10.0	10.0	16	100	0.0051	0.015	0.015	17.5 (0.69)	26.5 (1.04)	10.2 (0.4)	2
New AHR1300	13.0	13.0	16	100	0.0034	0.010	0.010	23.5 (0.925)	28.7 (1.13)	10.2 (0.4)	2

**AHS: High Temp Surface Mount**

Part number	$I_H^*$ (A) $R_1$ max.	$I_H^*$ (A) $R_2$ max.	V max. (Vdc)	I max. (A)	R min. ( $\Omega$ )	$R_1$ max. ( $\Omega$ )	$R_2$ max. ( $\Omega$ )	Dimensions (millimeters/inches)			Fig.
								A (max.)	B (max.)	C (typ.)	
New AHS080-2018	0.8	0.8	16	70	0.170	0.550	0.550	5.44 (0.214)	4.93 (0.194)	1.52 (0.060)	3
New AHS160	1.60	1.6	16	70	0.050	0.150	0.150	9.40 (0.370)	6.60 (0.260)	3.00 (0.118)	3

**ASMD: Surface Mount**

Part number	$I_H^*$ (A) $R_1$ max.	$I_H^*$ (A) $R_2$ max.	V max. (Vdc)	I max. (A)	R min. ( $\Omega$ )	$R_1$ max. ( $\Omega$ )	$R_2$ max. ( $\Omega$ )	Dimensions (millimeters/inches)			Fig.
								A (max.)	B (max.)	C (typ.)	
New ASMD030	0.23	0.23	60	10	0.98	4.800	4.80	7.9 (0.31)	5.4 (0.21)	3.2 (0.125)	3
New ASMD050	0.39	0.39	60	10	0.029	1.400	1.40	7.9 (0.31)	5.4 (0.21)	3.2 (0.125)	3
New ASMD075	0.60	0.60	30	40	0.029	1.000	1.00	7.9 (0.31)	5.4 (0.21)	3.2 (0.125)	3
New ASMD100	0.90	0.90	30	40	0.098	0.480	0.48	7.9 (0.31)	5.4 (0.21)	3.00 (0.118)	3
New ASMD125	1.04	1.04	15	40	0.057	0.250	0.25	7.9 (0.31)	5.4 (0.21)	3.00 (0.118)	3
New ASMD150	1.27	1.27	15	40	0.049	0.250	0.25	9.4 (0.370)	6.60 (0.260)	3.00 (0.118)	3
New ASMD200	1.73	1.73	15	40	0.05	0.120	0.120	9.4 (0.370)	6.71 (0.264)	3.00 (0.118)	3
New ASMD250	1.97	1.97	15	40	0.035	0.085	0.085	9.4 (0.370)	6.71 (0.264)	3.00 (0.118)	3

## Definitions

**$I_H$**  = Hold current—maximum current at which the device will not trip under specified conditions.

**$I_{max}$** . = The highest fault current that can safely be used to trip a PolySwitch device under specified conditions.

**$V_{max}$** . = The highest voltage that can safely be dropped across a PolySwitch device in its tripped state under specified fault conditions.

**$R_1max$** . = Maximum device resistance under specified conditions measured 1 hour post trip or post reflow.

**$R_a max$** . = Maximum device resistance under automotive conditions specified in PS400 measured 1 hour after stress has been removed.

**$R_{max}$ . Initial** = Maximum device resistance under specified conditions as supplied.

**Trip Current** = Minimum current at which a device will trip under specified conditions.

### WARNING!

- Operation beyond maximum ratings or improper use may result in device damage and possible electrical arcing and flame.
- These devices are intended for protection against occasional overcurrent or overtemperature fault conditions, and should not be used when repeated fault conditions are anticipated.
- TR and TS devices are not intended for continuous utility line voltage such as 120/220 V or 240 V.

---

### Agency approvals for PolySwitch devices:

PolySwitch devices, where appropriate, have been tested and have gained the following safety agency approvals:

- UL Component Recognition in Category XGPU2, Thermistor Type Devices
- CSA Component Acceptance Class 9073 32, Thermistors—PTC Type
- TÜV Rheinland Certification, PTC Resistors



## Voltage Rating for Telecom Devices

For Raychem Circuit Protection telecom devices (TC, TGC, TRx, TSx) there are two applicable voltage ratings. These are  **$V_{max}$ . Operating** and  **$V_{max}$ . Interrupt**. To help understand the nature of these two different voltage ratings the following definitions are provided:

**$V_{max}$ . Interrupt:** Under specified conditions this is the highest voltage that can be applied to the device at the maximum current. Devices have been designed to trip safely under higher power level cross conditions, as listed above, to assist equipment in meeting the appropriate industry conditions.

**$V_{max}$ . Operating:** For telecom devices this is the voltage we have used to obtain component recognition under UL1434. Raychem Circuit Protection devices (TC, TGC, TRx, TSx) are certified at 60V but can withstand higher  $V_{max}$ . Interrupt conditions as noted above.

For the purposes of this brochure we have included in the table of electrical ratings the more applicable  $V_{max}$ . Interrupt value.

**Worldwide Headquarters**

308 Constitution Drive  
Menlo Park, CA 94025-1164  
Tel (800) 227-7040  
(650) 361-6900  
Fax (650) 361-2508

[www.circuitprotection.com](http://www.circuitprotection.com)

[www.circuitprotection.com.hk](http://www.circuitprotection.com.hk) (Chinese)

[www.raychem.com/go/jpn/polyswitch](http://www.raychem.com/go/jpn/polyswitch) (Japanese)

**South America****Argentina**

Tel 54-11-4394-5150  
Fax 54-11-4326-9985

**Brazil**

Tel 55-11-816-0066  
Fax 55-11-816-0301

**Chile**

Tel 56-2-209-8211  
Fax 56-2-223-1477

**Colombia**

Tel 57-1-218-2460  
Fax 57-1-218-2472

**Peru**

Tel 51-1-221-4165  
Fax 51-1-421-0368

**Uruguay**

Tel 59-8-982-2428  
Fax 59-8-982-2430

**Venezuela**

Tel 58-2-242-6475  
Fax 58-2-241-8260

**Europe****UK/EIRE/****Nordic Countries**

Tel (44)-1793-572-244  
Fax (44)-1793-573-178

**Germany/Austria/  
Switzerland/  
Eastern Europe**

Tel (49)-89-608-9386  
Fax (49)-89-608-9394

**France/Benelux/  
Italy/Iberia**

Tel (33)-1-3440-7289  
Fax (33)-1-3440-7288

**Other Countries**

Tel (32)-16-351-321  
Fax (32)-16-351-319

**Asia/Pacific****Australia, Sydney**

Tel 61-2-9890-3944  
Fax 61-2-9890-3977

**China, Beijing**

Tel 86-10-6581-5606  
Fax 86-10-6581-5608

**China, Guangzhou**

Tel 86-20-8330-9933  
Fax 86-20-8385-6139

**China, Hong Kong**

Tel 852-2738-3401  
Fax 852-2735-1185

**China, Shanghai**

Tel 86-21-6485-3288  
Fax 86-21-6485-5109

**India, Bangalore**

Tel 91-80-559-1485  
Fax 91-80-558-6039

**Japan**

Tel 81-44-900-5110  
Fax 81-44-900-5140

**Korea**

Tel 82-2-3415-4654  
Fax 82-2-3486-1786

**Malaysia**

Tel 6-04-644-0931  
Fax 6-04-644-9521

**Philippines**

Tel 63-2-867-8641  
Fax 63-2-867-8661

**Singapore**

Tel 65-486-6126  
Fax 65-484-0661

**Taiwan**

Tel 886-2-2662-9788  
Fax 886-2-2662-4684

**Thailand**

Tel 66-2-617-1938  
Fax 66-2-617-1939

*PolySwitch, SiBar, miniSMD, microSMD, and nanoSMD are trademarks of Tyco Electronics Corporation.*

*All information, including illustrations, is believed to be reliable. Users, however, should independently evaluate the suitability of each product for their application. Tyco Electronics makes no warranties as to the accuracy or completeness of the information, and disclaims any liability regarding its use. Tyco Electronics' only obligations are those in the Company's Standard Terms and Conditions of Sale for this product, and in no case will Tyco Electronics be liable for any incidental, indirect, or consequential damages arising from the sale, resale, use, or misuse of the product. Specifications are subject to change without notice. In addition, Tyco Electronics reserves the right to make changes-without notification to Buyer-to materials or processing that do not affect compliance with any applicable specification.*